

HEWLETT-PACKARD JOURNAL

MAY 1985

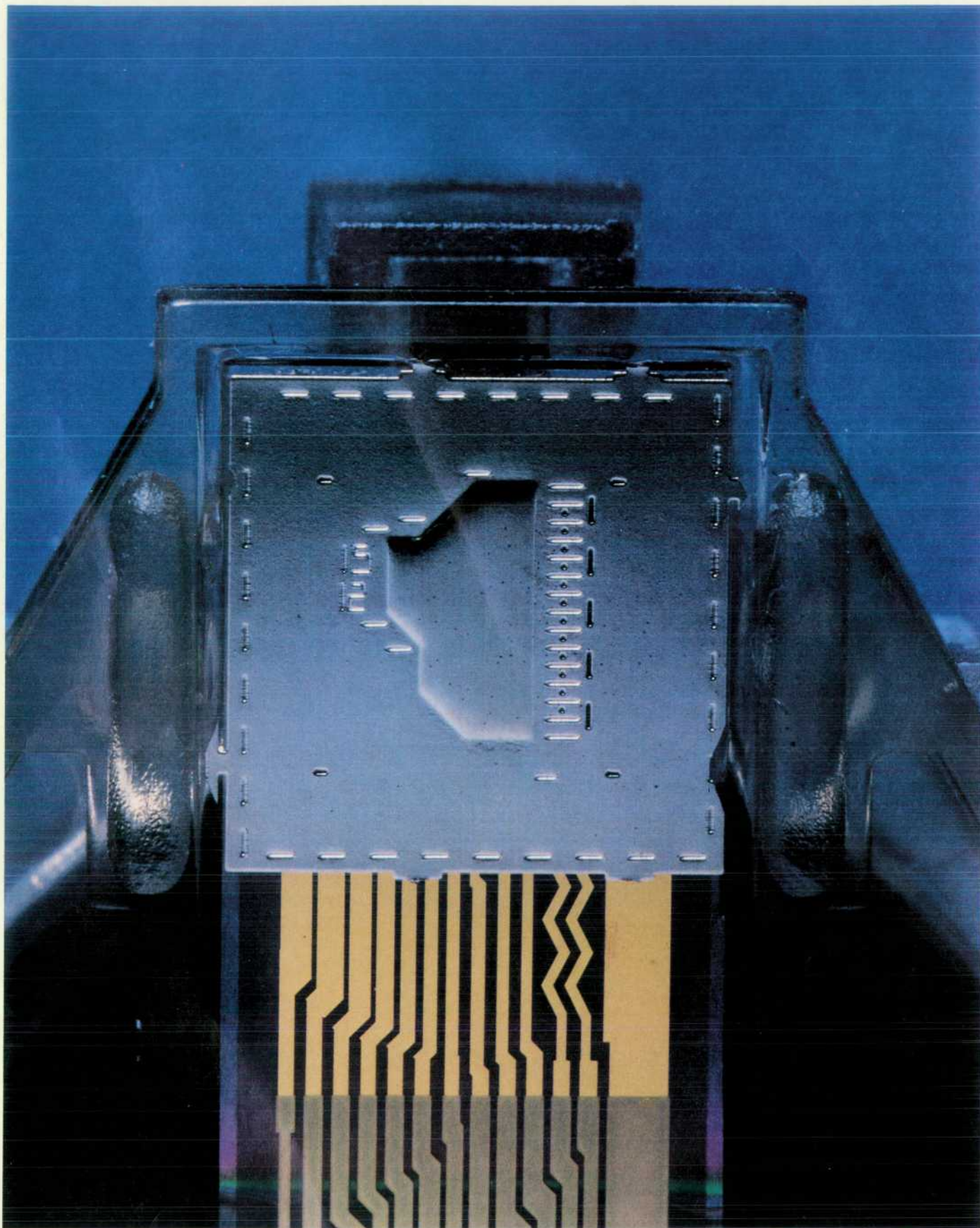

HEWLETT·PACKARD JOURNAL

May 1985 Volume 36 • Number 5

Articles

4 **History of ThinkJet Printhead Development**, by Niels J. Nielsen *They started out by punching holes in brass shim stock with a sewing needle.*

7 **Mass-Producing Thermal Ink-Jet Printheads**

9 **Preventing Hydraulic Crosstalk**

11 **An Inexpensive, Portable Ink-Jet Printer Family**, by Cheryl V. Katen and Thomas R. Braun *Quiet high-quality printing, no messy ink reservoirs to fill, and battery operation are some of the features of the ThinkJet Printers.*

13 **Alignment of Bidirectional Text**

14 **Printhead Interconnect**

16 **Custom VLSI Microprocessor System**

18 **Home Switch Design**

27 **Development of the Thin-Film Structure for the ThinkJet Printhead**, by Eldurkar V. Bhaskar and J. Stephen Aden *Using microscopic thin-film devices to vaporize ink for ink-jet printing imposes severe electrical, thermal, mechanical, and chemical stresses on the film structures.*

32 **Where the Ink Hits the Paper. . .**

33 **The ThinkJet Orifice Plate: A Part with Many Functions**, by Gary L. Siewell, William R. Boucher, and Paul H. McClelland *This tiny electroformed part conducts ink from the reservoir and channels it to an array of integral minute orifices where it is selectively vaporized to eject ink droplets for printing.*

35 **Electroforming**

38 **Viewpoints—Managing the Development of a New Technology**, by Frank L. Cloutier *How you do it may determine the commercial viability of a breakthrough technology.*

39 **Authors**

Research Report

21 **Thermodynamics and Hydrodynamics of Thermal Ink Jets**, by Ross R. Allen, John D. Meyer, and William R. Knight *Clever modeling and computer simulations were done to understand and predict the behavior of a new printing device.*

Editor, Richard P. Dolan • Associate Editor, Kenneth A. Shaw • Assistant Editor, Nancy R. Teater • Art Director, Photographer, Arvid A. Danielson • Support Supervisor, Susan E. Wright
Illustrator, Nancy S. Vanderbloom • Administrative Services, Typography, Anne S. LoPresti • European Production Supervisor, Michael Zandwijken • Publisher, Russell M. H. Berg

In this Issue



Like most of our issues, this one deals with the design of HP products—in this case, HP's ThinkJet family of portable thermal ink-jet printers. The ThinkJet Printer was an instant market success. It has the speed, reliability, and low cost of a conventional dot matrix printer, but is quieter and smaller, has better print quality, and is battery powered and easily portable. Unlike most design stories, however, the ThinkJet story has an important extra element: a new technology was involved. Thermal ink-jet printing—boiling ink to make it spit out of a hole and make dots on paper—was, so far as anyone at HP knew at the time, the original idea of John Vaught of Hewlett-Packard Laboratories. The great potential of this new idea infused the project with an excitement that carried through the many months of research and development that were needed to take the idea from primitive prototypes to a commercially successful product. There was a midcourse shock in the sudden discovery that Canon, Inc. had had the thermal ink-jet idea earlier, a dilemma resolved by the signing of a technology exchange agreement between the two companies. In the article on page 4, Niels Nielsen recalls some of the milestones in the development process, giving us an idea of what it was like to be there. Early on, knowledge had to be acquired about the physics of thermal ink jets so the design could be based on a thorough understanding of the phenomenon. This research is the subject of the report on page 21. The thin-film structure and the orifice plate of the ThinkJet printhead are described in the articles on pages 27 and 33, including the ingenious method of making the orifice plates by plating metal onto a mandrel and then peeling off the ultrathin finished plates. The article on page 11 describes the ThinkJet Printer family and the design of the inexpensive printing mechanism that carries the thermal ink-jet printhead. In his Viewpoints article on page 38, Frank Cloutier gives us a management perspective on the ThinkJet project, providing insight into the guidance and control that are needed to keep another "breakthrough technology" from becoming just another commercial failure. Our cover is a closeup view of the orifice plate.

Credit for pulling this issue together goes to Associate Editor Ken Shaw, who did an outstanding job of coordinating the efforts of authors at HP Laboratories in Palo Alto, California and the HP Divisions at Vancouver, Washington, Corvallis, Oregon, and San Diego, California.

-R. P. Dolan

What's Ahead

In the June issue, native language support for the HP 3000 Computer will be the subject of one article, and six articles will cover the mechanical and electrical design of the HP 2563A, 2565A, and 2566A Line Printers, a family of dot matrix impact printers with speeds of 300, 600, and 900 lines per minute.

History of ThinkJet Printhead Development

The principle was simple: ejecting a minute droplet of ink by momentarily boiling the ink. Applying it to the design of a commercially viable disposable ink-jet printhead required clever and persistent engineering.

by Niels J. Nielsen

USING THERMAL EXCITATION to eject droplets of ink through tiny orifices to print text was first proposed within Hewlett-Packard by John Vaught of HP Laboratories.* The first embodiment of this simple concept at HP's Corvallis Division (see box on page 7) marked the beginning of the development of a high-quality ink-jet printhead that could be manufactured in quantities large enough to support the projected demand. This device—constructed shortly after a new portable thermal printer product investigation began—featured an orifice plate made from a piece of thin brass shim stock in which a single orifice was punched by hand, using a sewing machine needle borrowed from an engineer's wife. This orifice plate was aligned by hand over a conventional thermal printhead substrate and fastened in place with a thin sheet of solid epoxy preform adhesive, which also served to define the gap between the substrate and the orifice plate. This simple printhead shot fountain pen ink several inches through the air, much to the delight of all concerned, and proved itself capable of eventually delivering enough ink to black out the objective lens of the microscope used to observe it in action.

Punching orifices in brass plates by hand was a hit-or-miss proposition and so was quickly replaced by laser drilling the orifices in thin sheets of ceramic material. A printhead of this type, manipulated by a graphics plotter as if it were a plotter pen, produced the first text printed by a ThinkJet printhead (Fig. 1). The letters were formed by ejecting a continuous stream of droplets through the head's single nozzle as the plotter moved the head to "draw" the letters.

Why Ink-Jet Printing?

What advantages does ink-jet printing offer to the print mechanism designer and ultimately to the end user?

Ink-jet printing is inherently quiet, since nothing strikes the paper except the ink. Conventional thermal printing technology—in which a thin-film resistor array is dragged across heat-sensitive paper that darkens in response to minute bursts of heat from the resistors—is just as quiet, but the application of conventional thermal technology to high-speed, high-quality printing is limited by several factors. The thermal mass of the printhead makes high print speed

and high dot density difficult to achieve simultaneously. This is because the combination of printhead scan speed and resistor duty cycle must be juggled to ensure that enough heat gets transferred from the printhead to the paper to make the paper change color. Turning up the power input to the printhead resistors to transfer this energy to the paper faster (thereby permitting faster printing) causes the spots "printed" by the resistors to be elongated in the direction of the printhead scan, limiting horizontal dot density. To an extent, this "streaking" can be decreased by cutting back the power input to the resistors as the head warms up during a print scan, but this necessitates either a complex power supply and perhaps a printhead thermometer to generate a control signal or a number of assumptions on resistor duty cycle to permit the system to run open-loop without overheating. Slowing down the printhead scan speed eliminates streaking but compromises throughput.

Vertical dot density (fixed by the resistor spacing on the printhead substrate) is limited by the size of the resistor required to transfer the appropriate amount of heat to the

INTRODUCTION
BACKGROUND
PROJECT GOALS
STATUS
.
.
CAPABILITIES
CONCERNS
TIMELINES

Fig. 1. First text printed by a ThinkJet printhead. A printhead was mounted on an X-Y plotter in place of the normal pen and fired on the fly as the plotter moved the printhead to write letters.

*Unknown to HP at this time, Canon, Inc. was independently developing this technology, referred to by them as "Bubblejet." For details, see the article, "Coping with Prior Invention," by Donald L. Hammond in the Hewlett-Packard Journal, March 1984.

paper. The exotic chemistry of thermal paper limits the print color to blue or black only, causes premature print-head failure if an unapproved grade of paper is substituted by the user, ruins the printed output if it is exposed to strong light, heat, or chemical vapors, and drives up the manufacturing cost of the paper. Ink-jet technology, while not without its own drawbacks, is not affected by these limitations to the extent that conventional thermal printing is. This gives it a number of customer satisfaction advantages.

Since ink-jet printing, unlike impact printing, does not involve striking the paper with a powerful array of electromagnetically driven hammers, the printer chassis and printhead scan carriage can be made substantially lighter and smaller since they no longer need to maintain close tolerances in the face of constant pounding action and vibration loads. This simplifies the printer mechanism design and decreases its cost by allowing a lightweight plastic chassis to be used, in addition to decreasing the torque and robustness requirements of the head scanning mechanism. This means that an ink-jet printer mechanism can, in principle, be made smaller, lighter, simpler, and less expensive than an impact printer of similar print quality. And this, in turn, means that ink-jet technology is a natural choice for a compact, low-cost printer product, provided, of course, that the printhead design goals can be met.

Why Portable?

If ink-jet technology is compact, lightweight, and low-cost, why not portable as well? Portability traditionally implies battery operation in the calculator and computer marketplace. But battery operation places severe constraints upon printing technology; for a printing method to be considered portable, it must be energy-efficient enough that the battery power pack needed to operate the printer for a reasonable time is not so large as to render the product nonportable. In this way, battery mass considerations eliminate impact mechanisms from portable applications because of their power-hungry electromagnetic hammers and large carriage drive motors. Even conventional thermal printheads are only marginally applicable to portable printing. Ideally, the printhead in a portable printer should consume no more power than the electronics in the printer, which is another way of saying that a portable printer's energy budget is dominated by its motor drives and precious little remains for other functions (such as putting readable marks on paper, ironic as that may seem), lest the battery pack turn the product into something better used as a boat anchor.

To put one mark on a piece of paper, a full-sized impact printer, such as the HP 2934, consumes 6 millijoules of energy. A smaller, but still not portable impact printer, the HP 82905A, consumes 4 mJ per dot. The portable, thermal HP 82162A Printer does only slightly better at 3.4 mJ per dot. But thermal ink-jet technology requires only ≈ 0.04 mJ to print one dot. This enormous improvement in energy efficiency means that a portable, 80-column, page printer capable of several hundred pages of output per battery charge became feasible for the first time.

For these reasons, the thermal ink-jet technology looked like a novel way of addressing a market need—almost good

enough to bet on. So the conventional portable thermal printer project mentioned earlier and already in the preliminary investigative phase at HP was studied as a possible first application of the still undesigned thermal ink-jet printhead. In essence, this involved retrofitting a partially designed printer mechanism with a wholly new type of printhead, which at the time was only slightly more than a laboratory curiosity. This represented an enormous gamble: could the printhead be designed and built in time for the printer to use it? Could the printhead really be made cheaply enough to justify itself as a consumable? Would the printhead even fit in the mechanism?

Initial Development

Having demonstrated that the basic concept would work, the engineers started work on some refinements. Laser-punched orifices in glass or ceramic substrates were rough and irregular in the punched condition and were not easy to clean up. So a switch was made to laser-punched stainless-steel shim stock which could be chemically polished after punching to yield a smoother bore.

Meanwhile, we had problems with ink oozing out of the orifices and accumulating on the outside of the orifice plate. Antiwetting coatings as tried by at least one other ink-jet printer manufacturer were too hard to apply and too easy to remove, so we took a hint from one manufacturer's technical data sheet on their piezoelectric printhead and prevented the ink drooling by drawing a negative hydrostatic head on the fluid circuit feeding ink to the head. A small J-tube manometer using gravity to draw a one-inch vacuum inside the ink reservoir cured the drooling problem and allowed us to excite more than one orifice at a time without

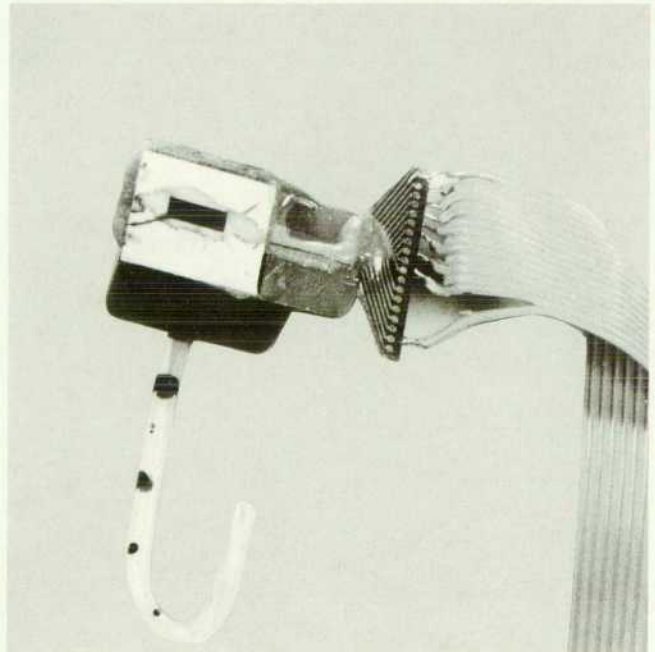

Fig. 2. (a) Prototype printhead using a stainless steel plate with seven laser-drilled orifices. A J-tube manometer provided a negative hydrostatic head for the horizontal ink feed. (b) Text printed with this prototype ejecting ink droplets at a rate of 50 drops/second for each orifice.

clogging adjacent orifices. As a result, we were then able to produce our first dot-matrix text with a thermal ink-jet printhead using a prototype shooting plotter pen ink out of seven orifices at what seemed to be a blinding speed of 10 characters per second (Fig. 2).

We cautiously pushed the speed up and improved the orifice plate cleanliness as time went by, and then we shrunk the center-to-center spacing of the resistor elements to 0.25 mm by using developed photoresist walls to hold back crosstalk. This gave us our first reasonably sized characters (Fig. 3). The next step was to machine some less-clumsy substrate carriers and try the printhead in a printer to get some idea of how it might behave as a real printhead. This was done with a modified HP 82905A Dot-Matrix Printer (Fig. 4).

One of the engineers at the Corvallis Division had an idea at this time for electroforming the orifice plates to get smooth and accurately positioned bores more easily (see article on page 33). So we went back to a center-to-center spacing of 0.5 mm to test out this idea. At this point the droplet size was getting close to being the right value and the ejection velocity was approaching its eventual value.

Print Quality

One of the most fundamental initial design criteria for the proposed thermal ink-jet printhead was that it provide better print quality than that provided by the HP 82905A Dot-Matrix Printer it was intended to replace in HP's product line. This was achieved by increasing the number of vertical dots in the font beyond the nine dots used in the HP 82905A, thereby making the characters more fully formed, and by exploiting the ink droplets' tendency to bleed together once on the paper, thereby masking the normally jagged appearance of dot-matrix text. Rough estimates of printer cost and desired printing speed indicated that a 12-dot head was not unreasonable and that it could be supported by the custom processor under consideration for the printer at a maximum printing rate of about 150 characters per second.

The orifice plate fabricated by the electroforming process in use at the time featured a nozzle spacing of about 0.25 mm, which was felt to be close to the minimum spacing that the process would permit without having to split a single column of nozzles into two staggered vertical arrays for greater vertical dot density. The two-column approach was ruled out because it would allow small head velocity variations in the printer to introduce visible dot placement errors during printing. While a closed-loop printhead position control system could, in principle, prevent this, stringent cost restraints on the printer mechanism prohibited this approach and thereby limited printhead resolution to about 100 dots per inch vertically based on 0.25-mm spacing.

Twelve nozzles on 0.25-mm centers yielded a print zone 3 mm tall, which for a font with three descenders gave the

THIS MESSAGE WAS PRINTED WITH A ST HELENS HEAD AT 800HZ (7.5
IS 3 MILS OUTSIDE AND 4 MILS INSIDE [] PLATE THICKNESS IS 4.7

Fig. 3. First text with reduced resistor-to-resistor spacing. Orifice plate had eight orifices ejecting ink droplets at 800 Hz.

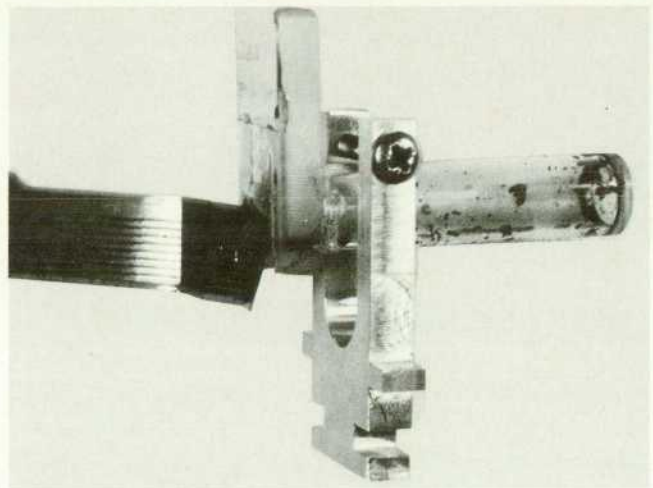

Fig. 4. Prototype printhead modified for use in HP 80905A Dot-Matrix Printer.

product group an uppercase character 2 mm tall (excluding ink spread on the paper). This size the printer designers considered small, but acceptable (see Fig. 5).

The Next Stage

By this time, the printhead development team was fabricating heads with 12 orifices on 0.25-mm centers using orifice plates electroformed out of nickel and featuring built-in separator walls to prevent crosstalk. We had shrunk the resistor size to the point where preheating the resistors before firing was no longer necessary to vaporize the ink quickly, which simplified the drive scheme. Experimentation found that a six-microsecond firing pulse offered the best compromise between minimal power consumption and voltage sensitivity.

Up to then, ink had been fed around the edge of the glass substrate and underneath the orifice plate. Core drilling was proposed as way of getting a more direct ink feed and allowing a simpler glue line for assembly. Soon thereafter we got prototype molded plastic parts on line and then had something that started looking and printing like a reasonable printhead (see Fig. 6), especially when we got our first pressure-contact flexible circuits to hook it up to a breadboard system.

At that point we had demonstrated that the printhead might be made small enough to fit into a portable printer, that it could print fast enough to beat a competitor's printer, that with 12 nozzles 0.25 mm apart it could beat the same printer for print quality, and that ganged assembly would

HERE IS THE ENTIRE CHARACTER SET

ABCDEFGHIJKLMNPOQRSTUVWXYZ 1234567890 !@#%&'()*=-@+;[]?/

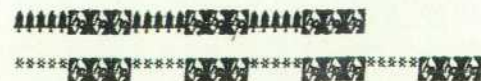

Fig. 5. Text produced with 12-nozzle orifice plate. Nozzles are spaced on 0.25-mm centers in a single column.

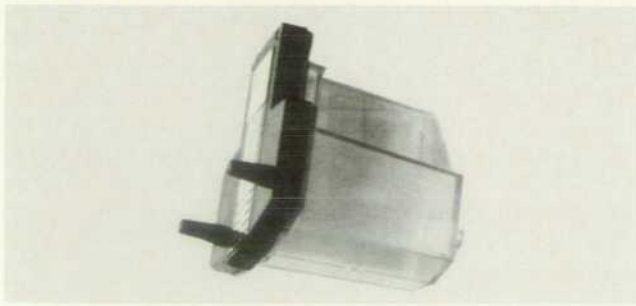

Fig. 6. Prototype injection-molded head assembly.

work. We then shifted our focus from blue-sky engineering to concentrating on hammering the printhead into something we could build for use in the new portable printer being defined at that time.

Why Disposable?

Early ink-jet printers used permanent printhead assemblies in which, with one exception, ink was plumbed out to the printhead carriage through a system of flexible hoses leading from a remote ink bottle. These plumbing systems were generally quite complex and delicate, since they were forced to include priming pumps, tiny shutoff

valves, pressure regulators, filter screens, bubble traps, and the like to isolate the dynamics of droplet ejection from inertially generated pressure surges in the moving hoses and to keep the printhead from choking on dirt or air bubbles introduced into the feed lines by refilling the remote ink reservoir. The cost, complexity, and reliability problems associated with these ink plumbing systems slowed consumer acceptance of ink-jet technology and limited its use to large system printer applications and other specialized markets until Siemens introduced its Pt80i ink-jet printing mechanism in 1979, which eliminated many of the plumbing problems by putting the ink supply (in the form of a user-replaceable cartridge) on the carriage. The printhead itself was of the piezoelectric drop-on-demand type, still fairly expensive and complex in its own right, although free of plumbing. This was partly because of the intricacies of its piezoelectric pump array (which does not lend itself easily to the economies of high-volume mass production), and partly because the ink cartridge exchange mechanism still required filtration, pressure priming, spill catching, and electrical out-of-ink sensing systems in addition to a needle-and-septum arrangement for piercing the ink cartridge and establishing ink flow to the nozzle array. These factors kept the cost too high and the physical size of the printhead too large to permit exploitation of

Mass-Producing Thermal Ink-Jet Printheads

The original embodiment of the thermal ink-jet concept proposed by John Vaught of HP Laboratories was an ink-filled conduit with one end connected to an ink reservoir and the other end open to the outside world. A tiny planar resistor was located on an inside wall of the conduit and bathed in ink. A short pulse of electrical power applied to this resistor caused it to heat up very quickly to a temperature far in excess of the nominal boiling temperature of the ink fluid. The boundary layer of ink covering the hot resistor promptly exploded into vapor, forming a bubble that covered the resistor surface. The bubble surface advanced into the surrounding fluid so vigorously that it could be thought of as a tiny piston, displacing fluid away from the resistor surface. Heat transfer out of the bubble caused the vapor within to condense with equal violence, and microseconds after its sudden appearance it collapsed back onto the resistor surface. The piston action displaced fluid out of both ends of the conduit, but by cleverly positioning the resistor along the length of the conduit, most of the displacement could be directed out the open end of the conduit rather than back into the reservoir. The result was that a tiny droplet of ink fluid was shot out the conduit by the pumping action of the vapor bubble. The surface tension of the fluid at the exit end of the conduit contracted the meniscus present there, which caused fluid from the reservoir to be drawn into the conduit to replace the volume of fluid just ejected. A piece of paper held close to the open end of the conduit during this process ended up with a spot of ink on it. Hence, an array of these resistor-driven nozzles could be used to print dot-matrix text or raster-scan graphics.

How to produce the conduit? The method investigated during the early days of thermal ink-jet research at HP Laboratories used a plate with a groove etched into its surface to form three of the conduit walls. This plate was then aligned over another plate that bore a thin-film resistor on its surface, thereby forming a square-cross-section tube with a resistor on one of its walls.

Ink was fed in one end of the tube and the other end aimed at a piece of paper. A row of resistors on the base plate, when properly aligned with an upper plate bearing a series of grooves, formed a row of nozzles shoulder-to-shoulder, which could then be used to print dot-matrix text.

After seeing a demonstration of this device firing a single stream of dots out of a single nozzle, Frank Cloutier of HP's Corvallis Division devised a new device structure which eliminated the need for a plate with channels etched into it (a difficult beast to fabricate) and which led naturally to a high-volume assembly technique. In this new embodiment, the plate bearing the resistor array is topped with a plate containing holes aligned over the resistors. Ink fluid flows out to the resistors through a thin space between the two plates and is shot straight out the holes when the resistors under them are energized. One advantage of this layout is that it is easier to make accurately formed holes than channels. More important, however, is the idea of forming the plate with holes (the orifice plate) as a small piece of a much larger plate containing many individual orifice plates, each with its own array of holes. This master plate can then be aligned with and attached to another master plate (the resistor substrate) bearing many resistor arrays. The resulting mass assembly is then cut up into individual pieces, each a complete orifice plate and resistor substrate assembly. In this way, only one alignment step is necessary to align many individual parts, and the orifice plate is attached only once for any one master plate pair, with the adhesive being screened or photodefined onto the resistor plate before assembly. The key to this processing concept is, of course, that each process step gets performed on a large number of parts all at one time, and it was this that would give thermal ink-jet technology a chance at meeting the cost goal necessary to make the ThinkJet printhead work as a consumable item.

piezoelectric drop-on-demand ink-jet technology in the low end of the printer market, already dominated by wire-hammer impact machines like the Epson MX-80.

To serve this portion of the printer marketplace adequately and for the resulting printer product to be cost-competitive with existing low-end thermal and impact printers, an ink-jet technology was required in which the cost of the printhead was roughly two orders of magnitude less than the state-of-the-art piezoelectric systems available. Accomplishing this goal requires that the cost of the printhead's droplet-generating mechanism be of roughly the same order as the cost of its expendable ink supply. This in turn presents the possibility of manufacturing the printhead assembly as a disposable unit, thrown away when its self-contained ink supply has run dry—no hoses, plumbing, or valves to add complexity and drive up cost or size. However, this approach can make other size and ink constraints more difficult to comply with.

Size and Ink Constraints

Size constraints on the proposed ThinkJet printing mechanism were severe. Only one cubic inch was available for the printhead and no space at all for an off-the-paper "service station" to house the printhead when not printing. To meet the printer design team's longevity needs, the printhead had to be able to print at least 500,000 (preferably 750,000) characters. Since the font under development by the printer team averaged about 17 dots per character, this implied that the printhead contain between 8,500,000 and 12,750,000 droplets in a reservoir within the allowed cubic-inch volume, only part of which would actually be available for ink storage. Since each droplet weighs about 3×10^{-7} gram and has a density of about one gram/cm³, the head would have to carry a worst-case usable ink volume of about 3.8 cm³ or about 23% of the total available volume. For these droplets to yield acceptable print quality at a density of 100 dots per inch, it is necessary for each of them to spread out on the paper to a final diameter of 0.01 in and preferably 0.012 in. This would guarantee an amount of dot overlap and bleeding sufficient to reduce cusping to an unobjectionable level, yielding smooth-looking characters with a minimum of the graininess ordinarily inherent in dot-matrix print. It was also assumed likely that the printer's output would be handled almost immediately after printing, making ink absorption and drying times of less than one second essential.

The absorption speed specification could be met with a simple ink composed entirely of water and a small amount of soluble dye, but such an ink would evaporate so quickly from the printhead nozzles as to clog them with crusts of precipitated dye after brief exposure to air. To prevent this, a capping station would be required for the printhead when it was not in use and there was no space available for such a station. In addition, because of its low viscosity, an all-water ink would create substantial amounts of mist and stray dots during operation, seriously degrading print quality. When such an ink was used in our printhead, the dots produced on the paper were less than half the required diameter, yielding text impossible to read. This problem could have been solved by drastically increasing the size of the ejected droplet, but this would have meant increasing

the reservoir volume beyond the printhead size constraints (or decreasing the number of characters that the head could print) in addition to violating the mechanism size constraint by requiring a capping station.

Traditionally, the evaporation rate of common felt-tip and roller-ball pen inks is reduced by replacing at least part of the water in the ink vehicle with a water-miscible fluid of low volatility such as glycerin or ethylene glycol. However, such a glycol/water ink mixture is absorbed very slowly by most common printing papers when applied to them by an ink-jet printhead, causing freshly printed text to smear if touched within ten minutes after printing.

The conflicting requirements of quick absorption time and freedom from nozzle clogging could both be met only if a paper specifically designed for ink-jet printing was used with the water/glycol ink solvent system. Hence, an ink-jet paper was chosen for use in the new printer, since at this time no ink system existed that was capable of producing 0.025-mm diameter dots from droplets weighing less than 3×10^{-7} gram without asymmetrical spreading or long absorption times on plain papers. (See box on page 32 for more details about the ink-paper system.)

Printhead Design Refinement

The plastic parts we were using at this time had nothing to prevent the ink from spurting out of the air return vent when a printhead cartridge was dropped. So a collapsible ink reservoir using a polyethylene membrane was tried. These new heads still needed gravity to work, however, and when dropped, could still be made to empty themselves—in this case through their orifices. The polyethylene also turned out to act like a screen door for gas transmission, causing the reservoir to accumulate air bubbles. To solve these problems, one of the engineers had the idea of using a rubber thimble of some sort to hold the ink. This thimble would be impervious to gas and so would have to deform as the ink was drained from it. This would tend to "suck back" the ink in the orifices, thereby preventing any drooling even in the absence of gravity. This new bladder-style ink reservoir had to be shoehorned into the printhead size constraint.

At this time, the glues used to assemble the printhead cartridge were not yet defined, with RTV silicone rubber being only a temporary candidate. A team of engineers hit the road to visit major glue manufacturers and eventually settled on the use of a UV-curable adhesive for attaching the substrate to the reservoir cartridge.

The means for connecting the printhead electrically to the printer mechanism had been solved by using a flexible printed circuit with dimpled contact pads pressed against the printhead substrate by an elastomeric backing (see box on page 14). All that seemed to remain to be done was to conduct reliability and life tests and to refine the fabrication process for production volumes.

Some Stumbling Blocks

The design team was now building printheads that contained airtight, rubber thimble, collapsible ink reservoirs. Electrical connector reliability had been tested and found satisfactory. The assembly adhesives were in the process of being life tested, shipping package samples were coming

Preventing Hydraulic Crosstalk

Hydraulic crosstalk in multiple-orifice ink-jet printheads is the phenomenon in which ink is ejected from orifices other than those desired. A problem arises when enough ink has been ejected out of these undesired orifices that it breaks free from the printhead and lands on the paper. A line of text printed by an ink-jet printhead with this problem will exhibit a random sprinkling of ink droplets superimposed on the text, seriously degrading print quality.

A related problem is orifice-to-orifice consistency, as indicated by horizontal banding (a print density variation) in dense graphics output when all orifices are being asked to eject droplets simultaneously. The character of such banding is a function of the order of droplet ejection from each orifice and is caused by fluid flow patterns in the printhead interfering either constructively or destructively in such a way as to alter the volume of ink ejected by a particular orifice in a systematic manner. This effect could be minimized by prudent selection of ejection order and repetition rate, but would not be completely eliminated.

The primary cause of these two problems is noncompliant coupling of the fluid in any one orifice (nozzle) with the fluid in all of the other orifices in the printhead by the basic rules of fluid mechanics. It is therefore highly desirable to decouple the dynamics of fluid motion in and near each orifice so that, in the case of the ThinkJet printhead, the bubble generation, explosion, and collapse and orifice refill processes occurring at one orifice will not perturb those processes at the other orifices.

Earlier Solutions

Other ink-jet printhead manufacturers have dealt with the decoupling problem by using clever manifold designs to supply isolation between neighboring orifices fed from a common fluid source. These methods generally require each driving element (piezoelectric or thermal) in the printhead to be supplied fluid through its own individual feed tube connected to the common supply reservoir. The length of these tubes is carefully chosen so that the inertia of the fluid entrained in a tube is sufficient to prevent large-scale fluid displacements back into the supply reservoir (and hence to other tubes) caused by droplet ejection. This is analogous to the use of series inductors in the supply lines to various electronic circuits fed by a common power supply to prevent transients from one circuit from modulating the supply voltage sent to other circuits.

Inertially isolating the orifices in this manner has two disadvantages. One, the extra feed tube length required introduces extra fluid drag into the fluid supply to the orifices, slowing down the rate at which they can refill after droplet ejection. This is analogous to the dc resistance of the series inductors in the electrical circuit model. This extra fluid drag sets a limit on printing speed.

The second disadvantage is the fact that the inertia of the entrained fluid in the feed tube, while suppressing crosstalk, also must be overcome to fill the orifices after droplet ejection. This inertia further restricts how fast the orifices can be refilled and

hence degrades printing speed even more. This behavior is analogous to the series inductors inhibiting large current surges in the electrical circuit model, starving the isolated circuits when their need for power suddenly increases.

For the above reasons, electric power supply circuits generally do not rely upon series inductor isolation. Instead, they use parallel capacitors for compliant isolation.

HP's Solution

Inserting compliant elements in parallel with the fluid circuit connecting the orifices to the supply reservoir is analogous to placing a capacitor from the electric supply line to ground, in parallel with the circuit connected to the supply line. In this electrical analogy, the shunt capacitors add no series resistance to the supply lines feeding the individual circuits. They also permit an individual circuit to draw a brief, large surge of current from the supply without disturbing the supply voltage seen by the other circuits connected to the same supply.

The fluid mechanic equivalent of the shunt capacitor is a narrow slot in the orifice plate (see article on page 33) of a ThinkJet printhead between the ink supply and the outside atmosphere. The meniscus of fluid welling up in this slot represents a compliance, since work would be required to enlarge the meniscus, as would be necessary to push fluid out of the slot. This is because the surface tension of the fluid at the fluid/air interface acts to minimize the area of the meniscus. Therefore, the meniscus integrates the fluid flow into the slot against the nonlinear opposing force supplied by surface tension and stores work as a function of meniscus displacement. When the pressure driving fluid out of the slot, enlarging the meniscus, is removed, surface tension retracts the meniscus to its zero-displacement position and thereby pumps fluid back into the supply line leading from the fluid reservoir to the orifice.

By placing such a slot across the feed line leading from the common ink supply to each of the orifices in the ThinkJet printhead, fluid surges from each nozzle are prevented from propagating back to the common supply and affecting other nozzles. This allows the use of very short feed lines without risking crosstalk or ejection-order-dependent horizontal banding. The shorter feed line length reduces fluid drag, allowing an increase in printing speed.

Although a round hole could be used in place of the slot, a slot is preferable since it is less likely to emit a droplet of ink for a given surface area. In addition, the quantity of stored work in the meniscus can be varied by merely lengthening the slot without increasing slot width. This is important in the design of an ink-jet printhead since the tendency for the printhead to deprime when mechanically shocked increases as the diameter of its orifices increases.

This solution was incorporated easily in the ThinkJet printhead because the slot can be formed with the same electroplating and photoresist steps used to form the orifices.

in, the in-house ink mix facility and process were designed, and the printhead engineering release specifications were completed.

Then a major stumbling block was discovered—the ink dye tended to bake on the substrate resistors in layers thick enough to affect printhead performance. This process was called kogation from the Japanese word “koga” for biscuit, so named for the appearance of the lumps of precipitated dye deposited on the resistors. This problem had to be

solved and was addressed by changing the composition of the ink (see box on page 32 for further details).

The printhead team began buying and installing production tooling and machinery and several months later started shakedown runs through the new facility. Last-minute engineering tweaks to the process and to the tooling were done to eliminate the inevitable bugs and the new ink process to cure kogation was developed.

However, two months away from the ThinkJet Printer's

introduction date, one stumbling block remained that stubbornly resisted all attempts at a solution—hydraulic cross-talk! It appeared that the better the job we did of firmly affixing the orifice plates to the resistor substrates, the greater was the printhead's tendency to eject droplets of ink from orifices adjacent to the orifice being excited. This, of course, caused unacceptably poor print quality. Operating on the assumption that some form of liquid compliance was necessary to offset the increased hydrodynamic stiffness of our preproduction printhead assemblies, one of the engineers finally saved the day by proposing a change to the orifice plate design that dampened the fluid surges in the ink supply caused by the resistor firings. (See box on page 9 for a detailed explanation of this problem and its eventual solution.) With this last-minute fix in place, the printhead (Fig. 7) and the ThinkJet Printer (see next article) were announced to the world in April of 1984.

A Backward Glance

From the beginning, the printhead development lagged the printer development and therefore, was schedule-driven throughout its history. This meant that the printhead design and manufacturing teams were often required to make engineering decisions that contained substantial amounts of schedule-driven compromises. Because this type of work had not been done before, there obviously were no roadmaps indicating appropriate paths and no cookbooks spelling out the necessary process recipes.

Some may attribute the successful completion of such a project in only a few years to luck and persistence, but there were other important reasons for this success. First, in the early days of the program, the various design teams were able to adjust to each other's requirements dynamically and were able to negotiate what could be done and what could not as the printhead and process technologies were being invented. Later, of course, as the printer and printhead designs became better defined and therefore less flexible, conflicts popped up. But none of these conflicts was so major as to reset the whole program; we resolved

them and then went back to work on our original goals.

Second, the performance goals for the printhead were not altered after we demonstrated breadboard feasibility. This allowed timely investigation of how to meet those goals, eliminating the "moving target" effect. Recall at the time of the breadboard demonstration we had electroformed orifice plates with walls built in, our dot size on the paper was correct, we had our ink vehicle defined, we knew how many resistors the head was going to have and how they would be arranged, we knew what to make the substrate out of, and we had the size and appearance of the head defined. After that, we still had a massive amount of engineering work to do turn the breadboard head into a real, live product, but we did not have to redefine the product after the breadboard stage. That is, there were no technology-driven hard resets after that point.

Finally, we did not start leapfrogging product descriptions at any time during the history of the project. (Leapfrogging is defined here as a nontechnology-driven redefinition of the product in midstream to account for things other than whether it will or will not work.) It is true that we were fortunate to have demonstrated a breadboard device that stood the test of time and thereby represented a technological contribution later when it was introduced, but the best way to succeed at achieving a specific engineering goal of turning a technology into a product is to drive the process with engineering alone. This way, the designers burn midnight oil, not blueprints.

Acknowledgments

Frank Cloutier managed the printhead development at HP's Corvallis Division and conceived the first embodiment of John Vaught's thermal ink-jet concept. Frank also resolved the particularly thorny hydraulic crosstalk problem that cropped up shortly before product introduction. Paul McClelland proposed and developed the electroforming process for fabricating the orifice plates and Dave Lowe conceived the idea of using a rubber thimble for the ink reservoir.

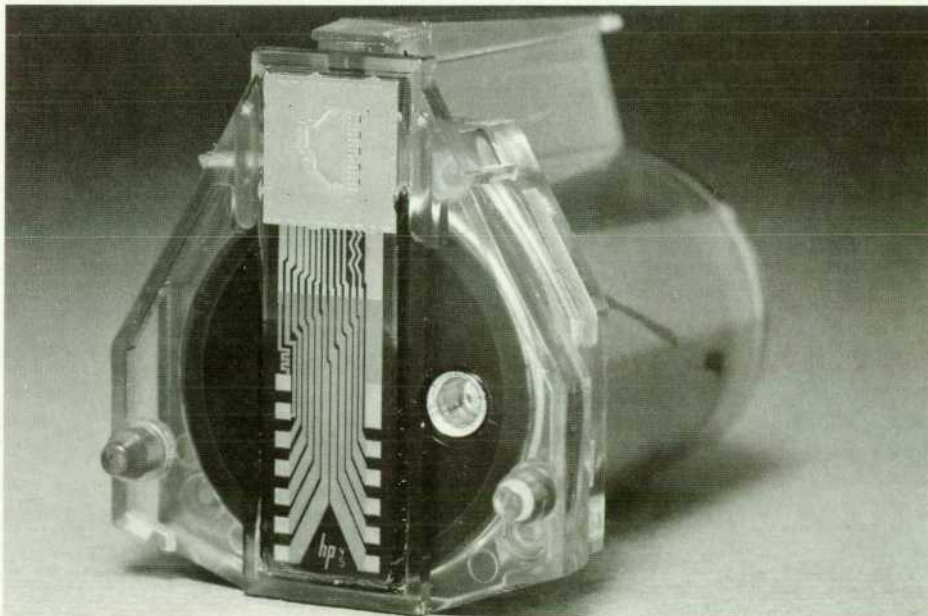

Fig. 7. The disposable ThinkJet printhead cartridge contains enough ink for 500 pages of normal text and can be easily replaced when its ink supply is exhausted.

An Inexpensive, Portable Ink-Jet Printer Family

Using a disposable ink cartridge and printhead, this low-cost family of printers offers personal computer users high-quality printing in a portable package. Four common I/O interfaces are supported by various members of the family.

by Cheryl V. Katen and Thomas R. Braun

THE DEVELOPMENT OF THE THINKJET technology provided Hewlett-Packard with the opportunity to make a significant contribution to the utility printer marketplace. The challenge was to produce a printer with the speed, reliability, and low cost of a conventional dot-matrix printer, and the technological advantages of quietness, better print quality, small size, and portability. To achieve this, we had to design a printing mechanism that took full advantage of the ThinkJet thermal ink-jet technology and could be manufactured inexpensively.

It is critical that such a printer offer complete compatibility with major brands of personal computers, and more important, be operable by the software run on these PCs. The challenge of using the disposable ThinkJet cartridge concept efficiently imposed additional objectives of simplifying the printhead insertion and removal procedure, providing a reliable printhead-to-printer interface, and optimizing the paper/ink system for maximum print quality.

At the time of this undertaking, there were no truly portable printers in the marketplace. Hence, the initial thrust of the project to develop the HP 2225 ThinkJet family of printers (Fig. 1) was to design the battery-powered, HP-IL

interface version. This would be a significant contribution and would allow HP to offer a printing solution for the emerging portable and transportable segment of the personal computing market.

Features

Four major input/output (I/O) interfaces are currently supported by the different models of the ThinkJet family: HP-IB (IEEE 488), HP-IL, RS-232-C/V.24, and the standard parallel 8-bit printer interface used by many PCs. Within the HP 2225 family, different ac line voltages are supported and one model, the HP 2225B, is available for rechargeable battery operation. The family supports HP's standard Printer Command Language (PCL) control codes for printers and an alternate control mode commonly used by non-HP systems.

The HP 2225 prints text at 150 characters per second (at a density of 12 characters per inch) and enhances its overall throughput by employing both bidirectional printing and true-logic seeking; these techniques minimize the non-printing distance traveled by the printhead to print the next line of text. To improve speed further, a 1K-character

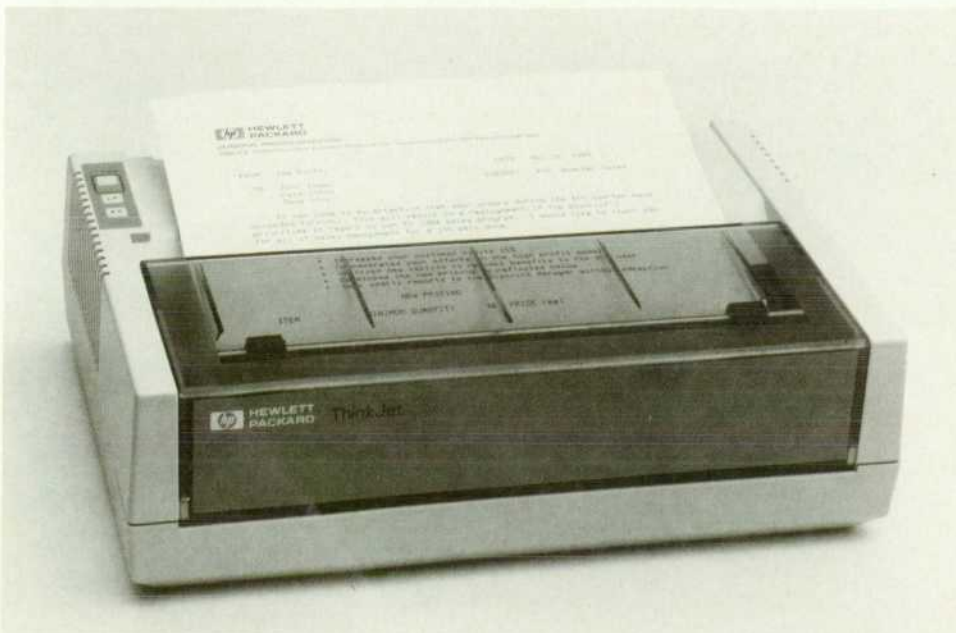

Fig. 1. The low-cost HP 2225 family of ThinkJet Printers provides fast, quiet, high-quality printing in a portable package. Four interface options and ac or battery operation are available.

Four print pitches

Compressed (142 characters/line)

Normal (80 characters/line)

Expanded compressed (71 characters/line)

Expanded (40 characters/line)

One-pass underline and one-pass bold (no slowing down!)

Fig. 2. Example of text (full size) printed by the HP 2225 Printers.

buffer is used to capture data from the I/O interface quickly. ThinkJet print quality is enhanced over that of many common dot-matrix printers by using a high-resolution 12×11 character cell, which supports rounded and eye-pleasing character fonts. Characters for eleven different languages are available.

The HP 2225 family has a comprehensive set of print features, including four character pitches (6, 10.7, 12, and 21.3 characters per inch) and underline, boldface, and over-strike capabilities, all of which may be intermixed on a single line of text (Fig. 2). To manage the appearance and position of a printout on a page better, the family supports line spacing of 6 or 8 lines per inch, variable text length, variable page length, perforation skipping, and automatic wraparound of excess characters onto a following added line of print.

For graphics printing, the ThinkJet Printers have two basic output densities: 96×96 dots per inch and 192×96 dots per inch (Fig. 3). In lower-density mode, up to 640 dots per row can be printed, and in higher-density mode, up to 1280 dots per row can be printed. Because of the sensitivity of the human eye to any minute misalignment in graphics images, all graphics output on the ThinkJet Printers is printed unidirectionally. All HP 2225 models accept graphics information in raster format (row by row). In addition, the HP 2225C and the HP 2225D accept

graphics data in block format (character cell patterns, line by line). A full graphics screen dump from a typical personal computer takes less than one minute to print.

The ThinkJet Printers accept single sheets of paper either 8.5 in wide or 21 cm wide and tractor-feed (fanfold) paper either 9.5 in wide or 24 cm wide. Paper loading is manual, but simple. While the printers can print on any kind of paper, a paper designed for ink-jet printing gives the best print quality.

Three classes of physical controls and indicators are available to the ThinkJet user: the power switch and its indicator, the paper advance switches, and the attention light and blue pushbutton. The power switch is located on the back panel and is monitored by an LED indicator on the front keypad. On the battery-powered HP 2225B, this indicator flashes to warn of a low-battery-charge condition. The paper advance switches allow the user to accomplish a form feed with a single keystroke and to advance the paper a dot row ($\frac{1}{96}$ inch) at a time, a line (either $\frac{1}{6}$ or $\frac{1}{8}$ inch) at a time, or continuously. The attention light indicates an out-of-paper condition with a steady light or an error condition with a flashing light. To recover from an out-of-paper condition, the user simply loads and correctly positions the fresh paper, and then presses the blue pushbutton to indicate to the printer that the paper is ready and that any suspended printing job may now continue.

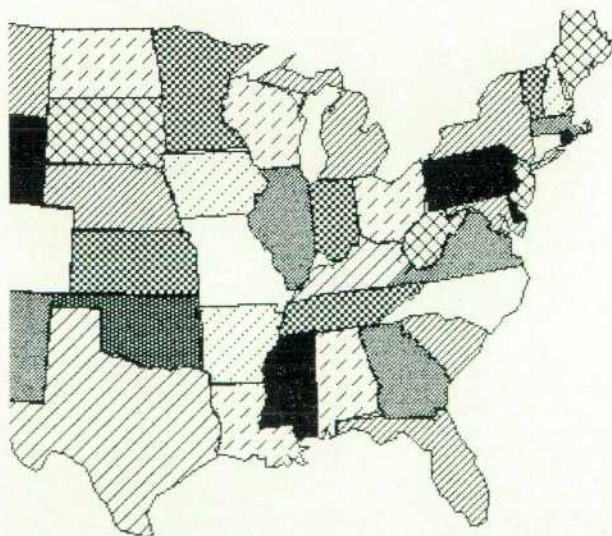

(a)

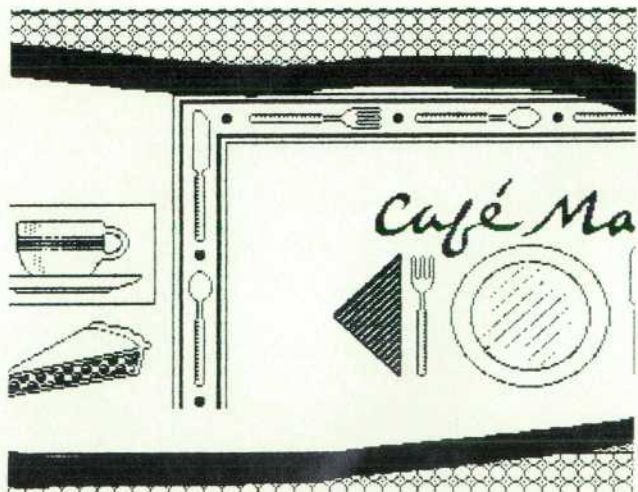

(b)

Fig. 3. Graphics output examples (full size). (a) 96×96 dots/in. (b) 192×96 dots/in.

Alignment of Bidirectional Text

It is desirable when printing bidirectionally to have the text printed in opposite directions aligned. In reality, this is generally not the case. For an ideal mechanism, each print position corresponds directly and precisely to the position control signals given to the printhead carriage step motor. But, mechanical and electrical differences in real carriage drive systems cause the print region to shift from the ideal. We call this shift in bidirectional print "backlash error." In the ThinkJet Printer we wanted to provide a means of compensating for backlash error that did not require adjustments on the assembly line and that would be valid over the life of the product. We decided to measure the factors contributing to backlash error using the printer mechanism itself as the measurement tool.

Although the servo systems employed in the ThinkJet Printer are open-loop in design, there is one channel of feedback that can provide the mechanism's carriage position—the home switch. The home switch is an optoelectrical device whose optical path is interrupted by a blade extending from the pen carriage. Initially, the home switch was added to the design to provide a means of determining the position of the carriage at turn-on. After the carriage position has been determined, the carriage servo is run open-loop with only occasional checks of the home switch to verify that the carriage is moving and not stalled.

Since we had the feedback of the home switch, we wondered if it could be used to help determine the backlash error. Our conclusion was that it could be used with sufficient accuracy to preclude the need for any other measurement scheme. By closely monitoring the output state changes of the home switch as the carriage is driven through it bidirectionally, we can determine the actual position of the carriage in relation to the motor control signals. This measurement is then used to make corrections during bidirectional printing. The text printed in one direction is shifted by the magnitude of the measured backlash error so that it is lined up with the text printed in the opposite direction. This measurement is made each time the printer is turned on and each time the printer's blue pushbutton is pressed to correct error conditions. In this manner the backlash error adjustment can be updated and remain accurate over the life of the product. (See box on page 18 for details of the home switch.)

Dave Lowe

Development Engineer

Robert P. Callaway

Development Engineer

Vancouver Division

Whenever the printer detects an error associated with printing, such as a printhead carriage jam, printing halts and the attention light is flashed to request the user's intervention. Once the user has corrected the error condition, pressing the blue pushbutton returns the printer to its functional state. During its power-up sequence, the ThinkJet Printer performs a nonprinting self-test. If this self-test fails, the attention light flashes to warn the user that a failure has occurred.

The two versions of the HP 2225C also have a set of eight switches on the back panel to allow easy selection of default conditions necessary to support a wide range of personal computer systems which communicate in different ways with their peripheral printers over the 8-bit parallel interface. The HP 2225D has five additional switches to select

the serial I/O protocol (baud rate, handshake, etc.).

An additional feature of the ThinkJet Printers useful for debugging of system problems is display function mode. In this mode, the ThinkJet Printer does not execute any control codes it receives, but instead just prints the control codes as they are received (with the exception of carriage return and disable display function mode, which are first displayed and then executed). Any printable data such as a line of text is printed normally. Thus, display function mode permits exact logging and monitoring of data and control codes transmitted to the printer.

How ThinkJet Printers Print

The HP 2225 is a nonimpact dot-matrix printer, which means that characters are formed on the paper by correctly positioning groups of individual ink dots to form the visual representations of different characters. A dot-matrix printer is characterized by its dot size and the shape of the character cell. The ThinkJet Printers have a 0.015-inch dot diameter and a character cell 12 dots high by 11 dots wide. This combination of dot size and character cell yields high print quality.

The dots are formed on the paper by ejecting individually controlled droplets of liquid ink from the disposable ThinkJet printhead. There are no reservoirs to fill and virtually no mess. Each printhead cartridge is good for about 500 pages of normal printing and can be replaced easily when it is exhausted. For more details about the ThinkJet technology and printhead, see the other articles in this issue.

The printhead sits in a carriage which is driven horizontally back and forth by a step motor, gear train, and cable system. This motion is tightly controlled by the HP 2225's custom microprocessor (see box on page 16), which also controls the spraying of the twelve individual vertical nozzles on the printhead. To print a text character, the microprocessor translates the character's ASCII representation into the proper dot pattern. Once the printhead is located in the correct horizontal position to begin printing a character, the microprocessor outputs a series of pulses to the twelve resistor-nozzle combinations as the printhead is swept horizontally across the width of the desired character. For example, a pitch of twelve characters per inch requires the output of eleven vertical 12-dot patterns per character at a spacing of 192 patterns per inch. Different character pitches are achieved by varying the number of vertical dot patterns per character cell. Hence, the character cells are always twelve dots high, but can vary in width depending on the pitch.

To print the next line, the microprocessor moves the paper upward using a second independent step motor, gear train, and drive system. Consistent with the low-product-cost objective, this system only moves the paper upward.

Graphics Output

Graphics printing is accomplished in a manner similar to text printing, except that the custom microprocessor receives the graphics data as a series of on or off dots (bit-mapped representation) in either a row-by-row (raster) manner or a column-by-column (cell pattern) manner. The microprocessor does not perform any translation of this

Printhead Interconnect

The development of a product that contributes in the areas of cost, function, and quality is always a challenge with broad ramifications. One area in which achieving these objectives for the ThinkJet Printer was important is the electrical interconnect to the printhead. The design objectives were to minimize the system cost per contact and maximize contact reliability with special attention to the areas of printhead contact fragility, contaminants, and user abuse while not adversely affecting the ease with which the printhead could be replaced.

The design finally chosen is one in which the contact array (Fig. 1) is integrated with the flexible printed circuit that carries the electrical drive pulses to the printhead. Connector mating is achieved by aligning the printhead cartridge registration pins with the mating holes in the carriage/interconnect assembly and then rotating a cam latch upward. This allows electrical contact to be made without lateral motion between the contact halves. This minimizes damage to the thin-film metals on the printhead contacts. The contact areas are backed with silicone-rubber pressure pads (Fig. 2), which allow electrical contact to be maintained over a range of environmental conditions and provide sufficient latitude for the design to work over a range of manufacturing tolerances.

Electrical contact is enhanced by dimpling the flexible circuit pads. This allows a greater degree of insensitivity to paper dust and ink contamination and also makes the contact area easier to clean if contaminants do become a problem. The dimples are

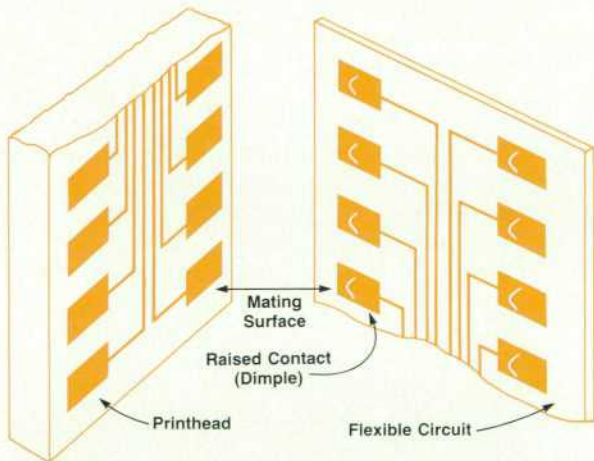

Fig. 1. The flexible circuit connecting the ThinkJet printhead to the printer electronics is made using standard industry techniques with the exception of the circular raised area (dimple) on each conductor pad. This dimple is created by plastically deforming the copper sheet and the plastic base dielectric before the contact pads are plated with a nickel barrier layer followed by a hard (Knoop 180-200) gold contact layer.

data. Instead, the ThinkJet Printer simply prints the appropriate pattern of on and off dots represented by the graphics data in a way similar to the printing of individual column patterns during text printing. To print graphics at a density of 96×96 dots per inch, only one pass across a given line on the page is required. Two passes across a given line are required for the graphics density of 192×96 dots per inch. In general, the HP 2225's buffer accumulates the maximum

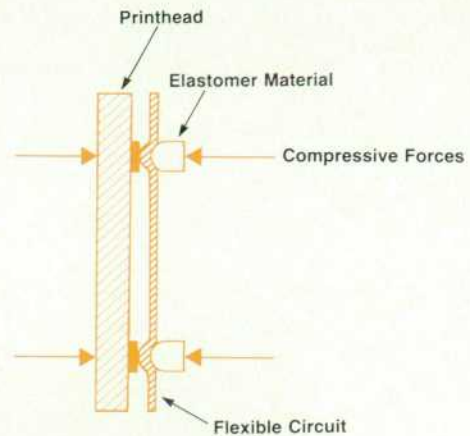

Fig. 2. The contact area of the flexible circuit is backed with an elastomer material and the whole assembly is compressed against the printhead contacts using a lever-activated cam. The elastomer provides a continuous force pushing the flexible circuit dimples against the mating printhead pads.

formed on the flexible circuit before the plating is applied. This results in the plating extending down over the edge of the etched copper pads and eliminates sharp etched edges which could snag cotton swabs, tissue, or other materials used to clean the contact area. Plating after forming also prevents the brittle nickel barrier layer from cracking during the forming operation.

Because the HP 2225 is a scanning-head printer, the flexible circuit traces must be able to withstand a high number of flexures without failure. By selecting a sufficiently large bend radius and by positioning the copper traces at the midpoint of the cross section, the required reliability is obtained.

Verification of any design can be a complex mixture of standard environmental tests and special tests aimed at uncovering weaknesses that could translate into quality problems. To make the most effective use of resources, a test sequence that makes use of fractional factorial experiment design was chosen to test contact reliability. This allows a smaller number of prototype samples to be used to eliminate variables whose effects are insignificant. A more thorough statistical study was then done on the remaining variables to determine their true significance. In this case, it was unnecessary to do a mathematical analysis since the significance of the various variables was obvious from examining the tabulated data. The only variable that proved significant during the test was the combination of body oil (fingerprints) and paper dust. These are readily removed from the product by using a dry or alcohol-dampened cotton swab.

Roy T. Buck
Development Engineer
Vancouver Division

amount of graphics data it can hold before beginning printing of the graphics. This maximizes speed and throughput by allowing the printhead to print up to 12 rows of dots during one pass across the paper for a graphics density of 96×96 dots per inch.

Hardware Design

The electrical design of the ThinkJet family followed the

design team's tactics of designing for low cost, maximum subassembly leverage, and high performance. The electrical block diagram in Fig. 4 represents the general internal structure of all ThinkJet Printers.

The power supply system must deliver various currents and voltages at different tolerances to the printhead, step motors, and digital logic. To achieve compatibility with the worldwide range of ac line voltages, the HP 2225A, the international HP 2225C, and the HP 2225D versions have a four-level, user-selectable input line voltage switch to permit operation using 110, 120, 220, or 240 Vac. The HP 2225C U.S.A.-only version eliminates this switch and operates only on 120 Vac. The ac power supply system consists of a 50/60-Hz transformer, different linear regulators for each output voltage, and reset circuitry that guarantees the proper voltage levels during the transients associated with turning the product on or off.

In the battery-operated version, worldwide compatibility is achieved by recharging the HP 2225B's batteries with the same group of rechargers already supporting other HP battery-operated products such as the HP 82161A Cassette Drive and the HP 82162A Printer/Plotter. To minimize cost, the two step motors are driven directly from the battery pack without any additional regulation. To achieve the voltage level and accuracy required by the printhead, a step-up switching power supply is used. To maximize the number of printable lines on one battery charge, the printhead power supply is turned off during long periods of nonprinting, eliminating the standby current drain associated with switching supplies. A linear regulator controls the logic supply and a group of comparators generate the correct low-battery-charge signals and prevent operation at an extremely low charge level while maintaining all I/O functions.

The brain of the ThinkJet family is the custom HP microprocessor mentioned earlier. This microprocessor controls all of the functions including data communications, printing, and keypad activity. The microprocessor chip also contains the operating system ROM and RAM, timers, and

other special circuits to minimize the number of electrical components. Except for minor modifications to the operating system firmware and the custom I/O circuits on the chip, the same microprocessor chip is used in all members of the ThinkJet family.

The character ROM and the buffer RAM are both HP custom parts chosen because of their availability from the development of an earlier HP product and their minimum number of interface lines. The character ROM is structured in 4-bit nibbles, an efficient match for the 12-dot-high printhead column and its column-by-column character font representation. The buffer RAM is also structured in nibbles, which is useful during the accumulation and printing of bit-mapped graphics data. The same character ROM (but with different fonts) and buffer RAM are used in all models of the ThinkJet family.

High-current transistors are used to drive the printhead and step motors, because the custom microprocessor does not have the capability to drive the printhead or the step motors directly. The precise printhead timing is generated with the microprocessor and the precise printhead power is maintained by the printhead supply. The step motor phases are correctly sequenced by the microprocessor. The step motor drivers have additional circuitry that suppresses transients during motor phase changes and hence improves the overall position control of these open-loop systems.

Two electrical components are closely associated with the mechanism—the home switch and the out-of-paper switch. The home switch serves as an initial print position reference point, acts as a detector during the process of checking for any printhead carriage stalls, and provides for a clever measurement of the mechanical system's backlash during the HP 2225's turn-on cycle (see box on page 18). The out-of-paper switch prevents printing without paper and permits recovery from an out-of-paper condition in a friendly manner that does not destroy data.

I/O Options

The ThinkJet Printers support four different data com-

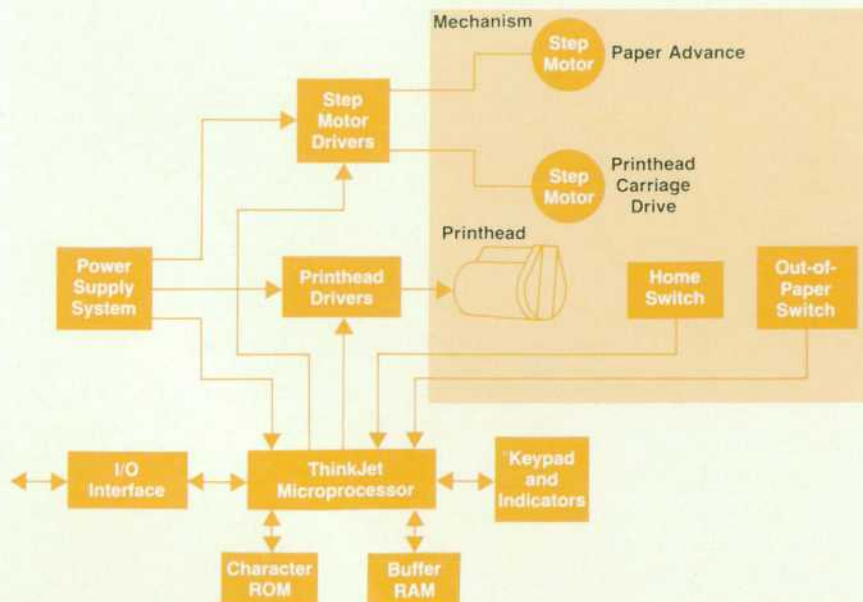

Fig. 4. Electrical block diagram of basic ThinkJet Printer.

Custom VLSI Microprocessor System

The ThinkJet Printer electronics are based on a custom HP integrated circuit that is a single-chip microprocessor system with a CPU, RAM, ROM, interface, timers, and I/O in one 48-pin package. Integrating these components saves power, cost, and printed circuit board space. Pin count is minimized by using a 4-bit bus for testing, which allows the microprocessor bus to be entirely internal. Communication with external RAM and ROM is accomplished through a custom 6-bit interface originally designed for the HP-71 Handheld Computer.

This IC was initially designed for HP's CMOS-C process and the first working parts were produced in this process. To reduce cost and increase processor bandwidth, it was later redesigned for HP's CMOS-G process. The redesign consisted mainly of a 25% linear shrink of the layout, which reduced its size by almost 50%. The die size of 7.85 by 9.78 mm in CMOS-C was reduced to 5.94 by 7.39 mm (Fig. 1) in CMOS-G.

Architecture

This custom chip uses a control-oriented microprocessor architecture. This architecture uses predesigned macrocells combined with specialized circuitry for special applications. The macrocells include a high-speed control-oriented 8-bit CPU, a configurable mask-programmed ROM, a configurable RAM, a programmable timer, an HP-IL interface, a crystal oscillator, a 4-bit test bus, and general-purpose I/O (GP-IO) pad cells. The ThinkJet IC uses two timers, 160 bytes of RAM, 10K bytes of ROM, one CPU, a test bus, an oscillator, and an HP-IL interface. These building blocks are combined with additional printer-specific circuitry for the ThinkJet products.

Hardware/Software Trade-Offs

At first it was believed that all of the I/O functions needed for the ThinkJet Printer could be performed in software using gen-

eral-purpose I/O pads. However, as microprocessor bandwidth became limited, some functions were offloaded to hardware.

A dot sequencer state machine was added to control the ejection of the ink dots from the ThinkJet printhead. The software loads a 12-bit register with the dot information for a specific column. On a timer interrupt, the software initiates the dot sequencer, which energizes the resistors in the printhead to eject the ink dots at the required time and in the proper sequence.

An external memory interface was added to communicate with the external character ROM and the external RAM buffer. This interface passes the nibble-wide data to or from the external memory while the software is either getting the next nibble or storing the last nibble.

The motor control functions, the front-panel keys and lights, the home switch, and the low-battery-charge and out-of-paper conditions are controlled using GP-IO cells.

Mask Programmability

Several mask-programmable options were included in the I/O sections to allow reconfiguration of the I/O any time the ROM code was changed. All of the special printer hardware may be reconfigured as GP-IO cells and all GP-IO cells may be reconfigured as either input, output, or bidirectional data paths. Other mask options allow changes in the dot sequencer state machine to conform to changes in the ThinkJet printhead specifications. These mask options allowed early development of this custom IC without requiring expensive full mask-set turnarounds, and made it possible to add interfaces such as standard parallel, HP-IB, and RS-232-C to the ThinkJet Printer later without additional mask-set turnarounds.

Ray L. Pickup
Development Engineer
Vancouver Division

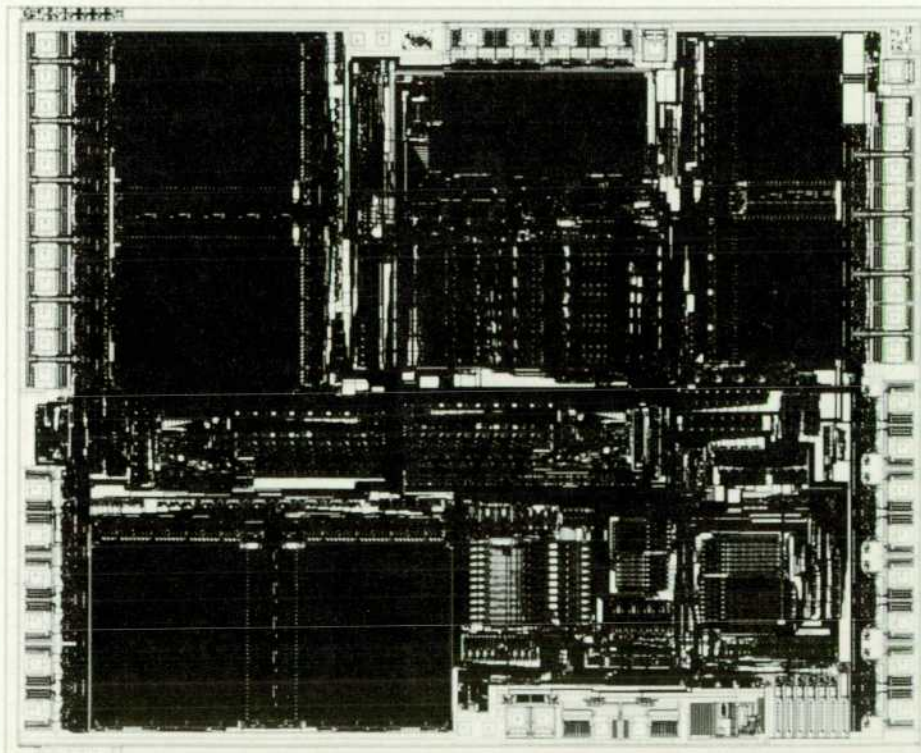

Fig. 1. Photomicrograph of custom microprocessor system integrated circuit used to control HP 2225 Printers. Chip size is 5.94 x 7.38 mm.

munications interfaces. The HP 2225A has an additional processor dedicated to data communications and two interface/bus driver ICs. An HP-IB transceiver IC receives and holds data from the HP-IB and the I/O processor interprets the HP-IB commands and protocol and transmits any data intended for the printer to the custom ThinkJet microprocessor by way of another custom IC.

The HP 2225B's data communications interface is HP-IL, a serial, low-cost, four-wire, multidevice interface loop patterned after the HP-IB. To minimize power consumption and cost, the analog and digital circuitry associated with the HP-IL interface is integrated directly on the ThinkJet microprocessor chip.

Since the standard parallel printer interface is a one-device (typically printer-only), eleven-wire interface, the HP 2225C can assume that all data strobed in is intended for the printer. With this simple interface, the data is latched by hardware and then read by the custom microprocessor. The HP 2225C multiplexes the latched data lines with the step motor signal lines since the number of available connections to the microprocessor chip is limited and the designers did not want to have to develop an additional IC.

The HP 2225D has a second processor and a UART (universal asynchronous receiver-transmitter) IC dedicated to data communications. The UART receives the serial data from the RS-232-C I/O and converts the data to an 8-bit parallel format. The added I/O processor buffers this parallel data and transmits it to the custom ThinkJet microprocessor when appropriate.

Firmware

The firmware of the ThinkJet Printers has three major performance objectives: communicating with the printer's controller at as high a data rate as possible, implementing a full feature set of printer capabilities, and printing at the highest possible print speed with the best visual appearance possible. In general, the printer's firmware must ensure the proper data flow from the hardware I/O interface to the actual printing on the paper. The firmware must also ensure that the proper control and actions are achieved in a timely and orderly manner.

The firmware is of modular construction (see Fig. 5) and is primarily a prioritized interrupt-driven system. Since printing is done by a scanning printhead method, any activity associated with marking the paper is given highest priority, (i.e., printhead carriage motion and ink-dot ejection). Other actions, such as interfacing with the I/O or polling the product's keypad, are done on a time-available

basis. Fortunately, these other actions can be time multiplexed with the printing of characters or graphics.

The background and master control module directs the activities for the other firmware modules. Without ever directly handling any data, the background and master control module passes control between all other modules in an orderly manner. This module monitors the status of the printer during its idle nonprinting time and determines when to initiate a line of printing based on whether or not the RAM buffer contains a complete line of printable data.

When a byte from the hardware I/O is presented to the printer, the interface module generates a low-priority interrupt to the background and master control module. When the background and master control module permits, control is passed to the interface module which, in the HP 2225A or HP 2225B, separates the interface commands from the printable data, acts on the interface commands, and passes the printable data to the input module. In the HP 2225C and the HP 2225D, all the bytes received by the printer are transmitted to the input module. The interface module also passes control to the input module.

After receiving data and control from the interface module, the input module performs one of four functions: storing any text data in the RAM buffer for future printing, processing and storing any graphics data in the RAM buffer for future printing, processing any control codes such as line feed or carriage return and storing them in the RAM buffer, or parsing other control codes such as escape sequences and either acting upon or storing them in the RAM buffer. Once the input module completes its task, it passes control back to the interface module which in turn passes control back to the background and master control module. During this interface and input process, a higher-level priority such as the ejection of ink dots can interrupt, take control, and after execution, return control to the interrupted interface or input function.

The RAM buffer is a hardware function. This 1024-byte buffer allows for the gathering of multiple lines of data, even while printing, thus increasing overall throughput.

When the background and master control module determines that a printable line is resident in the RAM buffer, the output module receives control. The output module is responsible for processing the four types of information stored in the RAM buffer by the input module. For example, the ASCII text characters stored in the RAM buffer are converted into the correct dot pattern based on the current print mode (bold, underline, etc.), the current print pitch, and the current print direction (right to left or left to right).

(continued on page 19)

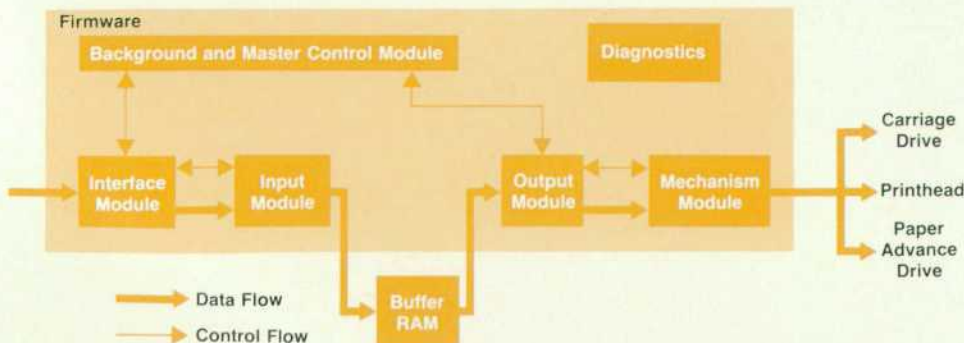

Fig. 5. Block diagram of modular firmware system used in the HP 2225 Printer family.

Home Switch Design

The ThinkJet Printer mechanism includes an optoelectronic home switch (LED-phototransistor pair) that serves two important functions. First, the switch is the only absolute method of sensing where the printhead carriage is in its range of travel. Second, the printer's firmware uses the home switch to measure the amount of backlash error present in the carriage drive system.

Mechanically, optically, and electrically, the home switch system appears simple, but it presented tough design challenges. First, the vendor specifications of various optical switches were sketchy at best. The few specifications available had been measured at different test conditions selected to make the numbers individually look good. This provided insufficient data to select a reliable operating point for the device. Second, the proposed backlash measurement scheme demanded accurate, reliable switching characteristics. Other concerns were the unknown effects of process variations, deterioration of the optical parts as they age, and performance in extreme environmental conditions. Finally, the solution had to meet the primary product design goals of high reliability and low cost.

The modeling and accurate measurement of backlash measurement error was a particular challenge. An ideal home switch toggles its output at the exact instant that the carriage reaches a certain fixed position, regardless of the direction or speed of carriage travel. Of course, a real sensor has an unavoidable delay before it responds to a change. Unfortunately, the firmware only knows the signals being sent to the carriage drive motor and the signal returned from the home switch, and cannot separate home switch sensing error from the mechanism position error it seeks to measure. Hysteresis in the home switch system has the same effect as backlash in the motor and gears, and the switching time of the home switch has the same effect as the response time of the motor. The design goal was to make the error contributed by the home switch as predictable as possible, so that the firmware could compensate for this error after making the measurement.

To measure the home switch error directly would require very accurate measurement of carriage position and home switch status as the carriage moves at full speed. To avoid using such complex equipment, simplifying assumptions led to simpler measurement methods.

The most accurate simple method assumed that the response time of the LED was much less than the switching time of the phototransistor, which was confirmed by manufacturer's specifications. A ramp function of forward current I_f in the LED simu-

lated the passage of the edge of an object through the light beam from the LED to the phototransistor. Each part was individually evaluated by determining the ΔI_f required to cause a certain change in the phototransistor's collector voltage, ΔV_c . This information, combined with the known speed of the carriage, yielded the desired slope of the current ramp. Then, I_f was adjusted to find $I_{f,th}$, which caused V_c to equal V_{th} , the threshold voltage for changing states. Finally, when the current ramp was applied, the delay from when $I_f = I_{f,th}$ to when $V_c = V_{th}$ was measured, first for one transition, and then for the other. These two delays added together represent the backlash measurement error contributed by the home switch system.

Fig. 1 shows the design of the home switch circuitry. The Darlingt transistor configuration used to switch the LED on and off employs an unused element in a Darlington array already used for driving the printhead. Using this component not only eliminates the need for an extra transistor, but also provides a handy reference voltage for the comparator. Since the LED requires only 10 mA, this voltage is steady at slightly more than one diode drop above ground. The comparator serves to minimize backlash measurement error by tightly controlling the hysteresis in the system.

The home switch system with the comparator meets its design goal with a backlash measurement error predicted to be within a range of 960 μs , during which time the carriage could travel 0.00404 inch, roughly 40% of the width of a printed dot.

Test Design

Selecting test values for I_f and load resistance R_L (see Fig. 1) was a particular problem. Good testing is "bold" testing, with the test limits set far apart, but not so far that the system will not function. When I_f and R_L were both set very low, the phototransistor could not pull V_c low enough. Many measurements depended on V_c going low, and thus could not be completed. As a result of missing data, the test results were difficult to analyze, and any conclusions drawn would have been suspect. Raising the lower limits for either I_f or R_L or both was not a satisfactory alternative, as this would remove from the factor space other areas where information was needed. The solution to this problem was a factor

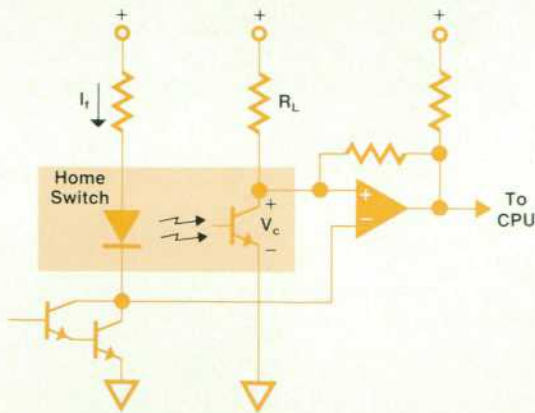

Fig. 1. Home switch circuit for ThinkJet printhead carriage position sensing and backlash error measurement.

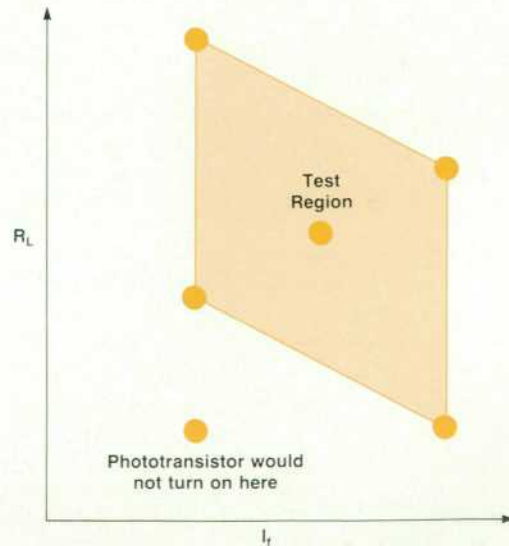

Fig. 2. An unconventional choice of test conditions avoids a region where the home switch would not function.

space shaped like a parallelogram (see Fig. 2), which avoided the problem area and kept the other areas of interest in the factor space. Data gathered with this test design, when analyzed by a computer, yielded all factor effects and interactions.

An aging test evaluated a sample of units operated at the corners of this parallelogram-shaped factor space. All units were tested when new, and then periodically during a test that lasted longer than twice the worst-case expected lifetime of the optoelectronic switch. The results of this test showed no significant deterioration with age, and no reliability problems at any point in the factor space.

During the development of this design, properly designed experiments provided statistically significant data to support many design decisions:

1. Early testing eliminated one potential vendor.
2. The optical switches evaluated were optionally available with narrow apertures over the emitter and detector. Contrary to expectations, testing revealed that the parts with narrow apertures were less accurate, with much more unpredictable backlash measurement error.
3. Analysis of test results predicted that for midrange values of R_L , changes in I_1 did not affect the system response significantly. This conclusion led to simplification of the design by eliminating components designed to regulate I_1 more tightly.

Andrew D. Sleeper
Reliability Engineer
Portable Computer Division

The output module passes the dot ejection information and control to the mechanism module.

The mechanism module controls the ejection of the ink dots, the printhead carriage motion, and the paper motion in the proper sequence to produce the desired printed output. The mechanism module has the highest priority in the system. If, during printing, the mechanism module has any spare time, it permits other functions such as interfacing to occur, but the mechanism module always reserves the right to interrupt any such activities. This interplay of the mechanism module with the other firmware modules permits the highest data communications rate consistent with scanning printing and a single microprocessor system. Once printing is completed, the mechanism module passes control back to the output module, which in turn passes control to the background and master control module, thus returning the system to the idle state.

The last firmware module is the diagnostic module, which is partially dependent on the other modules. The diagnostic module checks the printer's ability to function by testing the performance of the RAM buffer, the character ROM, and the microprocessor during the power-on self-test. If the user invokes the printable self-test, the diagnostic module acts as a pseudo input module and generates the pattern to be printed. The diagnostic module also generates the printer's signature analysis patterns when invoked by a service technician.

Packaging

The top case has an integrally molded paper guide to ensure that single sheets of paper are loaded straight and that the print region is positioned correctly on the paper. A plastic paper separator designed to lock into the mainframe separates the incoming and exiting paper when fanfold paper is used. This piece is removable; it is primarily intended to prevent friction between the edge perforations of fanfold paper. When not needed, it can be set aside.

Another significant objective was the elimination of a cooling fan. By venting the case in appropriate locations and by optimizing the distribution of heat-emitting components on the printed circuit board, the design team was able to dissipate enough of the heat build-up during operation to eliminate the need for a noisy, power-consuming fan.

Mechanism

The mechanism design approach was to integrate as much detail as possible into one piece. The final design consists of an injection-molded mainframe onto which the paper feed system and head drive system are mounted. The mounting is accomplished with screws or snap rings to simplify assembly. This approach also allows excellent control of tolerances by keeping the parts count low and integrating on one piece functions that must be positioned accurately with respect to each other.

The decision to mount the printhead drive separately was made because of the tight tolerance required to accommodate head position accuracy. Since the printhead carriage motor is the most used motor and it steps rapidly (1200 steps/s), this area was also the focus for noise minimization. The system consists of a step motor that, through a 5:1 gear drive, moves a drive drum and cable system to which the carriage is attached. The velocity of the carriage in the print region is constant enough to allow for interpolation of its position between the motor steps. As such, the mechanism is able to resolve horizontal movements as fine as a half dot position (0.005 in). The carriage rides on a single rod and is guided by a track molded into the mainframe. To the left of the home switch, the track is curved to cause the carriage to tilt back away from the paper for paper loading or printhead replacement.

The paper feed system uses a step motor directly mounted to the mainframe and driving, through a 6:1 gear train, a combination grit/pin-wheel drive. Each step of the motor moves the paper one vertical dot position (0.0104 in) and 16 steps are required to advance the paper one line (at 6 lines per inch).

Fanfold paper is pulled through the mechanism using pin wheels with pins of 0.5-inch pitch to engage the edge perforations. The right pin-wheel assembly is horizontally adjustable to allow for variations between metric and English paper widths.

A grit-wheel system feeds single sheets through the mechanism. Since the grit drive is engaged even when fanfold, pin-fed paper is in use, it is necessary to ensure that both drives work in harmony. Some slippage occurs when feeding fanfold paper because the pins on the pin wheel tend to elongate the holes in the edges of the paper. Hence, to maintain proper line spacing, the pin-wheel diameter is increased slightly above the theoretical diameter

to compensate for this slippage. However, the grit-wheel drive has very little slippage and its diameter does not need to be increased to maintain proper line spacing. This overcomes any feed problems that would otherwise occur when fanfold paper is in use.

Manufacturing

The utility printer market demands a quality product that can be manufactured in high volume. To achieve this, it was imperative that manufacturability be an important design objective. The ThinkJet Printer is designed for fabrication in a continuous assembly line and use of just-in-time materials flow. The assembly flow consists of two primary lines; one for the mechanism and one for the printed circuit board. These lines feed into a third line where final assembly and customized packaging take place. Each line has dedicated test stations to ensure functionality before the unit is passed on. Any rework that is needed takes place immediately and the line paces to a "quality" output rather than to quantity. For instance, if testing or visual inspection shows a problem on the mechanism, the whole line is halted while repair is made. This ensures that quality problems get maximum attention, workmanship defects are clearly identified, and associated procedures are changed immediately. This method of manufacture requires that the designers incorporate suitable checks or tests, and that routine adjustments be avoided.

During the design phase, a significant effort was required to ensure that all significant parameters were thoroughly evaluated and the corresponding critical dimensions were documented and verified for high-volume producibility at the part vendor's facilities and within HP manufacturing.

The product also underwent extensive life testing. The goal was to withstand 3.5 million print lines and 100,000 page movements without print quality deterioration. If a malfunction occurred, it was to be minimal and totally recoverable. In addition to HP's standard environmental testing, several special environments were devised. We were concerned that dry, low-temperature air would cause the paper to build a large electrostatic charge as it passed over the plastic platen of the mechanism. This condition was tested and it was determined that the best results could be obtained through the use of a conductive polymer in the platen, which eliminates the need for a tinsel strip or wire cage as required on some utility printers. Because of

limitations of conventional environmental chamber capabilities, the testing was done in the local mountains and was an extremely popular assignment during ski season.

One of the objectives for the project team was to maximize the flexibility of the manufacturing line. This means that necessary model changes and production volume changes must be easily accommodated. To accomplish this, we chose to assemble the mechanism using only simple tools. Some of the special design features used to accomplish this objective include several plastic-to-plastic snap details—the platen-to-mainframe assembly, the drive drum assembly, and the flexible-circuit-to-head-carriage assembly. All the rods are held in place with simple E-shaped snap rings and screws are used only where rigid joining of heavy or tensioned parts is required.

Inquisitive readers owning an HP 2225 Printer may also wonder why we use the "funny" screw heads that are making it difficult for you to disassemble your printer. The screw drive scheme was chosen to minimize the strain on operators who do the same action for eight hours per day. In this case, Torx™ drive heads have been found to minimize the possibility of repetitive motion injuries and operator fatigue.

Acknowledgments

The initial ThinkJet Printer development was spearheaded by Bernie Musch and Duncan Terry, and Ernst Erni provided guidance and support throughout the project.

Special thanks for their technical leadership, diligence, and perseverance goes to Brad Freeman, Charlie Gilson, Ken Johnson, Dave Shelley, and Dennis York.

Our heartfelt thanks goes to the engineers of the ThinkJet project. Rick Berriman, Cindy Bowline, Roy Buck, Larry Jackson, Pete Kehoe, and Paul Sassenrath developed the mechanism and package. Dave Allen, Joe Bauman, Brian Cripe, Alesia Duncombe, Kevin Hudson, Dave Lowe, Carol Peterman, and Janet Stearns developed the firmware and software. Bob Callaway, Doug Franz, Gordon Margulieux, Debbie Neft, Pete Nicholson, Dave Patton, Larry Plotkin, Jim Schwartz, and Andy Sleeper developed the electronics and integrated circuits. Don Haring, Gene Frederick, Chuck Jarvie, Klaus Kater, Eric Ross, and Steve Wade worked on the procurement and the manufacturing engineering teams, and Deby Cover was our project coordinator.

Thermodynamics and Hydrodynamics of Thermal Ink Jets

by Ross R. Allen, John D. Meyer, and William R. Knight

MANY OF THE SPECIAL FEATURES of Hewlett-Packard's ThinkJet technology depend on the formation, growth, and collapse of a microscopic bubble of vaporized ink. This compact energy source can be placed in the ideal location for a drop-on-demand ink jet—right at the nozzle. This allows the design of a compact, disposable, multinozzle printhead that is very energy-efficient and can be used in portable and battery-powered printers.

The components of the ThinkJet printhead are shown in Fig. 1. The assembly consists of a molded plastic case, ink bladder, front plate with ink filter and capillary, and thin-film subassembly. The elegant simplicity of this device belies the underlying complexity of the thermo- and hydrodynamics of the ThinkJet printing process.

In other drop-on-demand technologies, such as piezoelectric drive, the pressure pulse ejecting an ink droplet may be modulated in amplitude and duration to some degree by the electrical drive pulse. Similarly, a range of bubble impulses can be obtained in a thermal ink jet by choosing different voltage/pulse-width combinations. In each case, the operating point must produce very high fluid superheat to achieve repeatable and reliable vaporization. The pressure-time characteristics of the thermal ink-jet drive are further influenced by the selection of the ink, the thermal behavior of the substrate, and the geometry of the

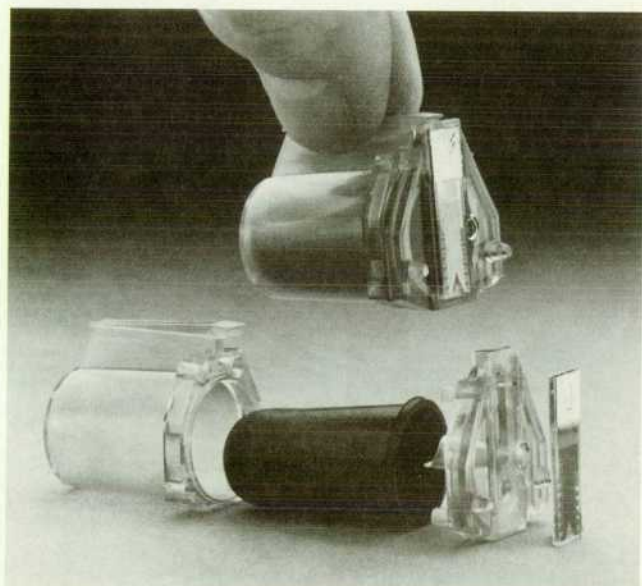

Fig. 1. ThinkJet printhead. The assembled printhead (top) is composed of a plastic housing (left), a rubber bladder to hold the ink (center), and a thin-film substrate assembly containing the ink-jet array (right).

heater and nozzle. Successful implementation of thermal ink-jet technology requires control of the bubble formation and droplet ejection processes through sophisticated thermal and hydrodynamic design.

Bubble Nucleation and Growth

Generation of thermal ink-jet vapor bubbles does not lie within the regime of conventional boiling. When a substance changes into the vapor phase under reversible heat addition, the process occurs at a well-defined temperature for a specified ambient pressure. Large thermal gradients, inertial limitations on vapor bubble formation, and the unavailability of nucleation sites produce nonequilibrium conditions allowing superheating of the ink. The amount of superheat is measured by the number of degrees above the boiling point required for vapor bubble formation, and superheat is only a few degrees for conventional boiling.

A thermal ink-jet vapor bubble that ejects ink droplets with repeatable velocity and volume is obtained only when the fluid/heater interface temperature approaches the ink's superheat limit. This is approximately 90% of the fluid's critical temperature (i.e., the point beyond which a liquid phase no longer exists). The critical temperature depends solely on the physical properties of the fluid, whereas the superheat limit depends on ambient pressure and fluid properties. For ThinkJet inks, the superheat limit is about 330°C at atmospheric pressure.

Bubble nucleation and the behavior of the ink fluid under superheated conditions determines the stability of bubble generation and droplet ejection. Three nucleation mechanisms are possible in a superheated fluid. Nucleation at surface sites occurs on a heated surface where vapor is trapped in minute cracks or pits. This can occur over a wide range of superheat conditions and depends on the size of the site, temperature gradients in the fluid near the heated surface, and whether vapor is present.

At fluid temperatures close to the critical point, both homogeneous and heterogeneous nucleation are possible. These two mechanisms involve the creation of bubble nuclei from fluctuations in molecular density occurring at elevated temperatures. Homogeneous nucleation occurs within the fluid and is characterized by the temperature at the superheat limit. Heterogeneous nucleation occurs at a liquid/solid interface and its characteristic temperature depends on the properties of this interface.

For a thermal ink jet, homogeneous nucleation with its independence from heater surface properties is a desirable mechanism for producing repeatable vapor bubbles. Unfortunately, it is difficult to create and maintain surfaces of sufficient perfection to eliminate surface sites. When present, these sites initiate nucleation before the superheat limit

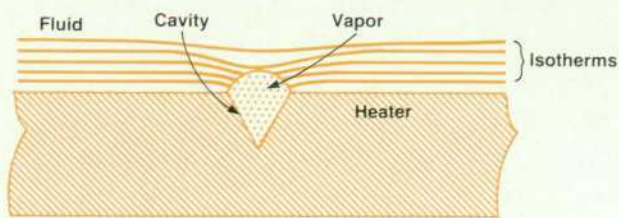

Fig. 2. Small irregularities in a heated surface create low-temperature nucleation sites for bubbles in the heated fluid.

is reached and the bubble nuclei thus created dominate the nucleation sequence by suppressing more energetic, higher-temperature nucleation mechanisms. Under these conditions, the release of energy is highly random and results in unstable droplet ejection. Much of the development of the ThinkJet technology involved understanding bubble formation and selecting conditions that inhibit low-temperature nucleation sites.

Low-temperature nucleation sites can be suppressed by high heating rates that quickly bring the fluid close to the superheat limit. Typical thermal ink-jet heaters generate power densities of 500 megawatts per square meter for periods of three to six microseconds. Since it would take about 100 million typical thermal ink-jet heaters to cover a square meter, the actual power is more manageable—5 watts.

Fig. 2 shows a vapor forming at a surface site. Conditions for bubble growth can be predicted from the isotherms in the fluid near the heater surface. These isotherms can be obtained analytically or from computer simulations. A model of the vapor bubble includes surface tension and the Clausius-Clapeyron relation between saturated vapor pressure and temperature. Results from this analysis relate heating rates and pulse widths to the quality of nucleation.

Fig. 3 shows temperature profiles in the fluid each micro-

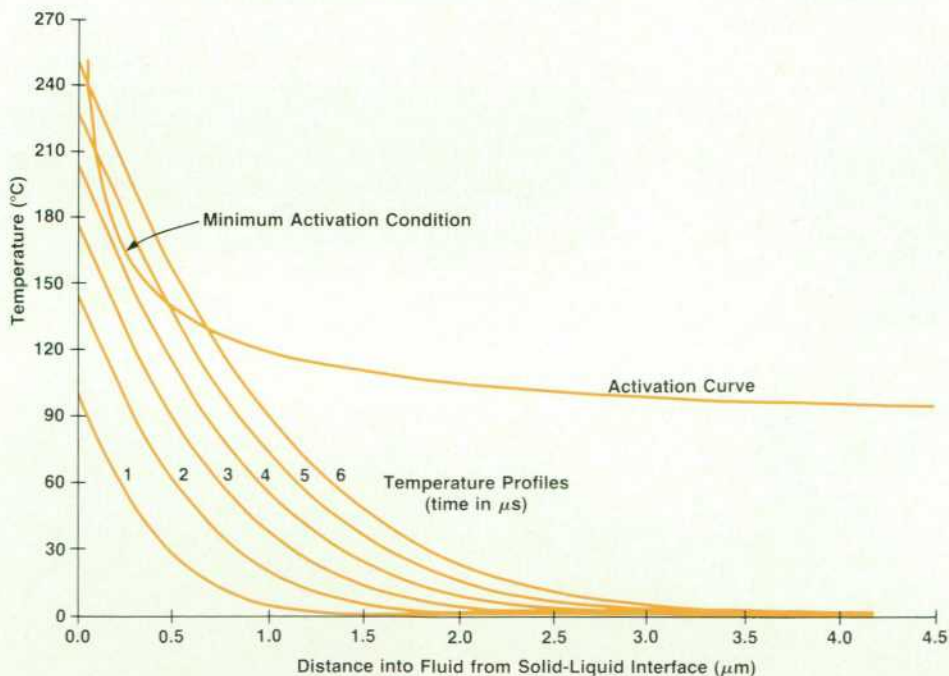

Fig. 3. Temperature profiles in the ink as a function of the duration of the heating pulse. The activation curve shows the temperature profile that must be exceeded for vaporization to occur.

second during a six-microsecond heating pulse. Superimposed on these profiles is a curve representing conditions for surface site nucleation called the "activation curve." When a temperature profile crosses this curve, nucleation will occur at the site whose temperature and characteristic size are determined by the point of intersection. For the heating rate used in this analysis, Fig. 3 shows that no nucleation can occur before 4.5 microseconds, and the first sites activated have a dimension of $0.25 \mu\text{m}$ when the superheat temperature is 170°C . There is no guarantee that surface sites are available for bubble nucleation when activation conditions are met, because the surface may not have features at this roughness scale and existing features may not be primed with vapor.

Vaporization will not occur across the entire heater surface if only a few random sites are activated at the end of the heating pulse, because these isolated bubbles cannot grow large enough before the fluid temperature relaxes below that required to sustain vaporization. Under practical operating conditions, nucleation will initiate at a few discrete sites and additional heating will quickly activate higher-temperature sites until nucleation occurs over the whole surface. Under these conditions, it is possible to obtain heterogeneous nucleation approaching the quality of homogeneous nucleation.

This model successfully interprets a wide variety of bubble behavior and explains qualitatively why high heating rates and short pulse widths produce more stable nucleation and droplet ejection. Under these conditions, bubble vaporization time after nucleation occurs is on the order of one microsecond and peak pressures approach 14 atmospheres, depending on the choice of fluid.

Thermodynamics of the Fluid and Thin Films

A cross-sectional view of a ThinkJet printhead's thin-film structures is shown in Fig. 4. It consists of a substrate of

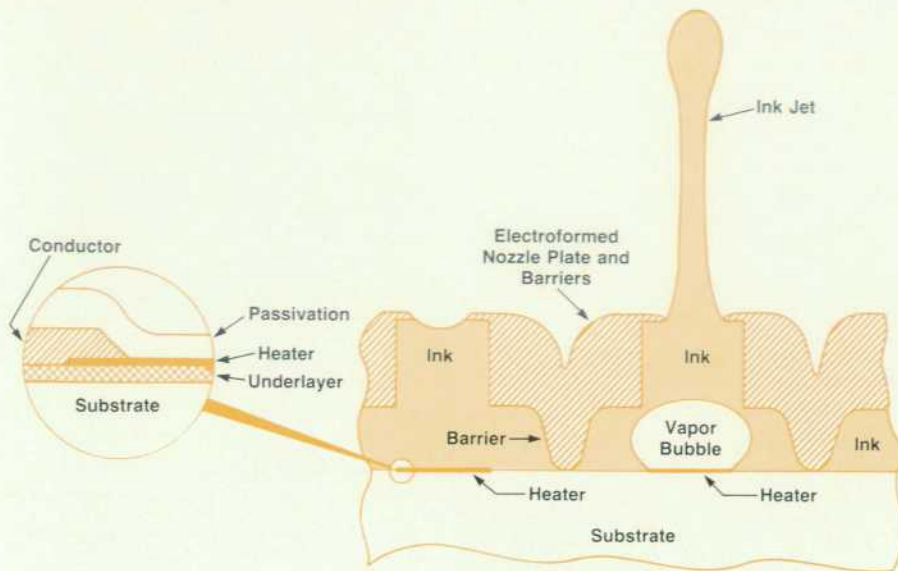

Fig. 4. Cross section of the thin-film structure for a ThinkJet print-head. The close-up view on the left shows the conductor-heater interface.

glass, an underlayer beneath the heater, a thin-film resistor heater, metallic electrical conductors, and a passivation layer. The substrate provides structural support for the thin-film structure, whose total thickness is less than $3\ \mu\text{m}$. The underlayer controls heat diffusion into the base from the heaters. A heater is formed by etching away portions of the conductor material, thus exposing the underlying resistor layer. The surface is covered with a passivation layer protecting the heaters and conductors from chemical attack.

Control of bubble nucleation requires precise thermal design of the substrate and thin films, but experimental temperature measurement is complicated by the short times and small dimensions of the heating process. A typical thermal ink-jet heater is 50 to $100\ \mu\text{m}$ square and $100\ \text{nm}$ thick, and can reach 400°C within five microseconds. Consequently, computer simulations have been an essential tool for prediction of temperature distributions within the substrate, thin films, and ink.

During a practical heating pulse, whose duration is two to six microseconds, heat can diffuse only a small distance into the fluid and substrate— 2 to $3\ \mu\text{m}$. For heaters 50 to $100\ \mu\text{m}$ square, the temperature field will be highly uniform across the resistor surface (away from the connections to the metallic conductors). Because printing requires many repeated pulses, and in actual operation heat diffuses into the substrate, ink, and nozzle plate, a temperature field can be predicted accurately only with a three-dimensional analysis. A three-dimensional model gives operating temperatures and can evaluate heat dissipation mechanisms, but is time-consuming to construct and evaluate and requires characterization of many physical processes. These processes, involving transient conditions and many materials, may have parameters that are unknown or difficult to measure. Fortunately, over the time scale of bubble lifetime (about 20 microseconds), a one-dimensional model adequately predicts the thermal environment over most of the heater surface and can be used to develop rules for substrate thermal design.

Fig. 5 shows the temperature profiles calculated from a one-dimensional model at two, four, and six microseconds after the start of a six-microsecond heating pulse. The one-dimensional model can simulate uniform, instantaneous nucleation over the entire heater surface. Choosing the temperature of bubble formation to be the superheat limit gives good agreement between analytical models of bubble growth and experimental results. But using this as a criterion for nucleation overestimates the initial pressure and bubble energy because the nucleation process is strongly time dependent.

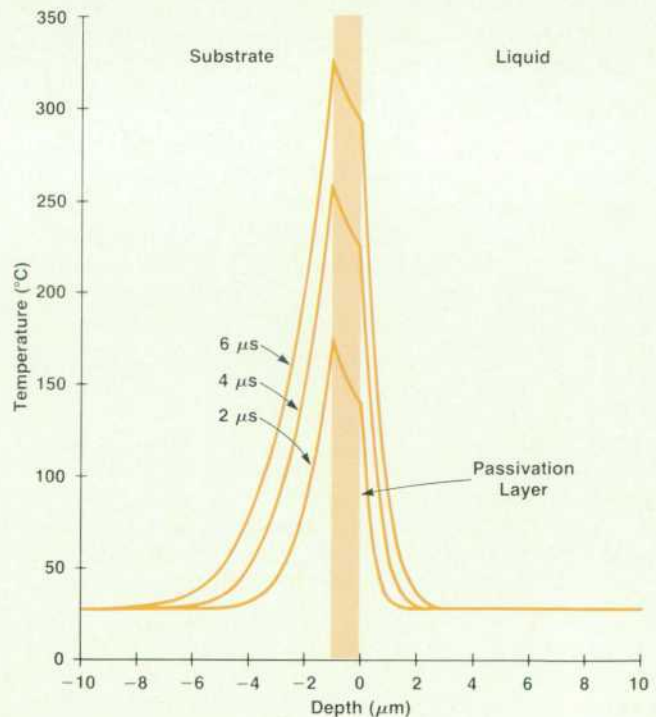

Fig. 5. Temperature profiles for structure in Fig. 4 calculated from a one-dimensional model for a $6\text{-}\mu\text{s}$ heating pulse.

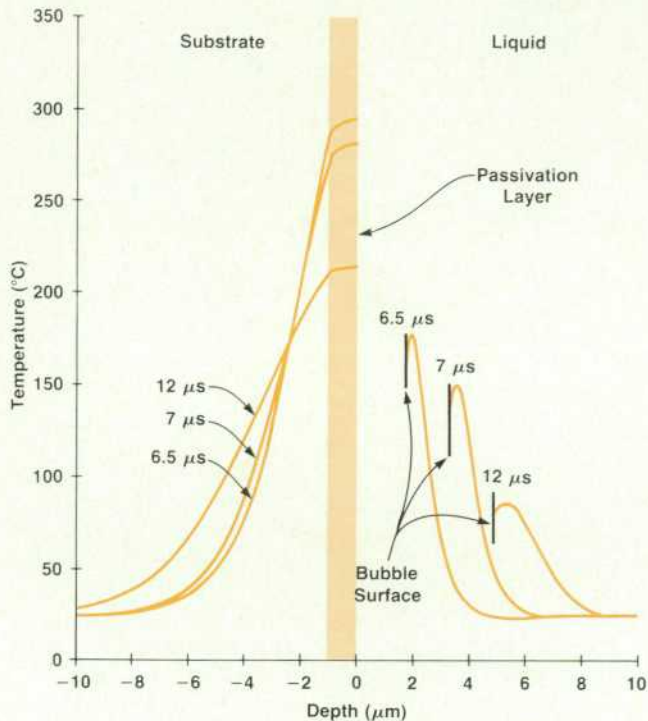

Fig. 6. Temperature profiles after bubble nucleation at $6 \mu\text{s}$ calculated from one-dimensional model. The bubble forms on top of the passivation layer and grows to the right.

This model assumes nucleation at six microseconds when the fluid reaches its superheat limit— 330°C . This is not inconsistent with the analysis of surface site activation presented in Fig. 3, because that model predicts only the minimum conditions for activation of the first site.

Fig. 6 shows the temperature field after bubble nucleation at six microseconds. Notice that the fluid temperature relaxes very quickly. The large temperature gradients near the bubble surface come from heat conduction to the vaporizing fluid and to the ink. The cool fluid ahead of the bubble removes energy available for vaporization at the advancing bubble wall. The decay time to ambient of the thermal profile from its initial state at bubble nucleation is several microseconds, and the high-pressure phase of bubble growth, which accelerates fluid in the ink-jet nozzle, is expected to be of this order. Experiments measuring bubble acoustic energy with high-frequency hydrophones verify that the pressure pulse has this short-lived character.

The thermal effects of the passivation layer are effectively analyzed with a one-dimensional model. Fig. 7 relates effective pulse energy to pulse width for no passivation and three thicknesses of passivation: 0.5, 1.0, and $1.5 \mu\text{m}$. The heating pulse energy required for bubble nucleation decreases with pulse width but increases with passivation thickness. Obviously, short pulse widths and thin layers are more desirable to minimize input energy and printhead heating.

A thicker passivation layer causes more heat to diffuse into the substrate. For continuous operation, the temperature of the entire structure increases, and this can affect bubble nucleation and degrade print quality. Furthermore, the temperature gradient across the passivation increases

with decreasing pulse widths. This means higher heater temperatures and greater thermal stresses, which affect reliability and useful life. It is possible to control heat dissipation and thermal efficiency through careful selection of the base material and use of an underlayer beneath the heater.

A base material such as glass has a low thermal diffusivity and heat builds up locally near the heaters. Since the ejection of warm ink represents about 50% of the printhead heat dissipation, efficient heat transfer between the substrate and the ink is an important design objective. This requires conducting thermal energy away from the heaters into a large wetted area.

A silicon base with a layer of silicon dioxide between the base and the heater greatly improves printhead cooling. Compared to glass, the higher thermal diffusivity of silicon promotes the lateral flow of heat along the fluid-substrate interface. The substrate is therefore at a more uniform temperature and more heat is transferred to the ink. The silicon-dioxide layer must be thick enough to insulate the heater from the silicon while the pulse is on, but thin enough to allow rapid relaxation of the temperature field between pulses. This ensures that the bubble collapses on a cool surface, preventing a secondary vaporization cycle. Typically, 1 to $3 \mu\text{m}$ of silicon dioxide satisfy both criteria for pulse widths up to six microseconds and repetition rates to 8 kHz.

Fluid Mechanics of the Bubble and Ink Droplet

Much of the experimental evaluation of drop ejection from thermal ink-jet printheads is done by microscopic

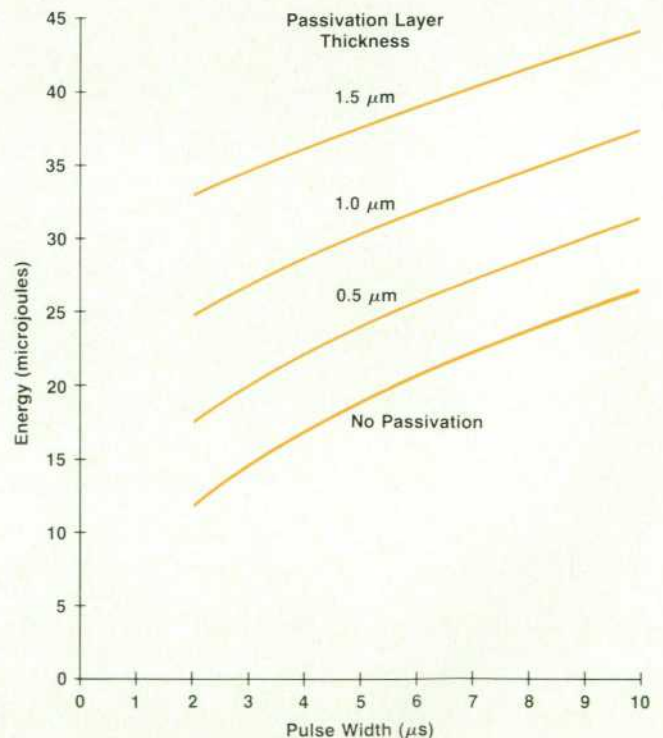

Fig. 7. Graph of effective pulse energy versus pulse width for no passivation and three different passivation layer thicknesses.

observation of droplets under flashtube illumination. Controlling the delay between the heating and illumination pulses allows observation of single or multiple drops at different times in the ejection cycle. Fig. 8 shows a drop 20 microseconds after the rising edge of the electrical input to the heater.

Measurement of drop velocity and shape are made with calibrated optics and photographic or video recording. Other important behavior such as refill time and drop stability (and quality) can also be studied optically. Special printheads with glass walls and nozzle plates have been fabricated to observe bubble expansion and collapse, drop breakoff, and refill within operating nozzles. But, even with these experimental tools, it is difficult to correlate observed effects with underlying physical processes.

A computer simulation of the thermal ink jet was developed to gain a fundamental understanding of the physics of drop ejection. The model was used to study the effects of nozzle geometry and bubble dynamics on drop formation. Fluid dynamics were modeled by the two-dimensional Navier-Stokes equations in cylindrical coordinates using a classical "marker-and-cell" finite-difference scheme. This method is used for fluid flows with liquid/vapor interfaces called "free surfaces." The evolving free surface is defined by marker particles that move according to fluid velocities near the surface.

Viscosity and surface tension are important effects at free surfaces of ink drops and vapor bubbles. For this study, new numerical techniques were developed for complete treatment of free-surface boundary conditions which include viscous normal and tangential stresses, surface tension, and continuity. Multiple sets of differencing schemes are used to compute these boundary conditions even when the surface becomes highly distorted. The model can simulate arbitrarily complex but axisymmetric nozzle shapes using a library of solid-wall boundary conditions for wall



Fig. 8. Photomicrograph of the ejection of an ink droplet 20 μ s after the application of the electrical pulse to the heater.

geometries near a computational cell.

The simulation code was written in Fortran and a typical simulation using a 4- μ m grid and a time step of 10 nanoseconds required about 70 CPU hours on a super mini-computer to model 50 microseconds of the drop ejection cycle.

In the simulations, the fluid is initially at rest and the nozzle meniscus is deformed by the subatmospheric pressure in the ink reservoir. (This pressure is generated by the deformed ink bladder and is necessary to prevent ink from flowing freely out of the pen.) Surface tension of the meniscus in each nozzle supports this subatmospheric pressure. The vapor bubble is given an initial pressure and volume and then expands as its surface moves with the local fluid velocities. The bubble pressure is computed from its volume using the perfect gas law. Velocities in the fluid are produced by the pressure gradients between the vapor bubble and the atmosphere and are affected by boundary conditions at the nozzle walls and free surfaces.

Fig. 9 shows graphical output from the simulation of a converging nozzle. The smooth nozzle contour is approximated piecewise along grid boundaries. The refill channel is simulated by an annular restriction and boundary conditions derived for radially symmetric, unsteady flow between two flat plates. The two-dimensional flow field is axisymmetric, and its graphical representation has been split into the velocity field (left half) and the pressure field (right half). The velocity field is described by streamers fixed at the cell centers. The length and direction of each streamer gives the local velocity. A streamer of one cell length represents a velocity of 10 m/s. The pressure field is filled with symbols whose size is proportional to pressure.

Fig. 9a shows the drop emerging five microseconds after formation of the vapor bubble. The bubble has expanded off the resistor. Its pressure is 0.43 atmosphere and its volume is 49 picoliters. Bubble surface velocities are now about 4 m/s. The pressure is close to atmospheric near the nozzle exit and within the drop (note the size of the pressure symbols). As the nozzle cross-sectional area decreases, continuity causes the fluid to accelerate against an adverse pressure gradient. The centerline velocity at the nozzle exit is 10 m/s and at the head of the drop is 16 m/s. Velocities in the nozzle are low except in a cylindrical region extending back from the exit. This nozzle is efficient because low velocities and gradients near the walls (except in the exit region) reduce viscous losses. Flow is seen out the refill channel in the lower left corner of the figure.

Fig. 9b shows the drop at 15 microseconds when the bubble begins to collapse. The bubble pressure is 0.22 atmosphere and its volume is 77 picoliters. The meniscus is reentering the nozzle at 8 m/s. A large velocity gradient is seen along the drop between the head (13.3 m/s) and the region of fluid behind the meniscus (-8 m/s). Outside the nozzle, some fluid is seen to have no axial velocity. Nearby, the drop diameter is decreasing as fluid flows back into the nozzle. Pressure within the drop is typically 1.06 atmospheres and increases to 1.1 atmospheres at the head and minimum-diameter region because of surface tension and the small radii of curvature. Although surface tension has an effect, drop breakoff is primarily driven by velocity gradients in the region near the nozzle exit plane, and these

arise from bubble collapse.

The nozzle meniscus moves back into the nozzle during bubble collapse. This "reflow" has a significant effect on breakoff, droplet shape, and distribution of fluid velocities. During bubble expansion, the nozzle throat is filled with fluid and its impedance is comparable to the refill channel's. Nozzle impedance decreases substantially when air enters the nozzle during bubble collapse. Because the refill channel is always filled, its impedance remains high while reflow provides most of the volume flow for bubble collapse. High velocities develop at the meniscus surface when little fluid mass supports a large pressure gradient.

At 24 microseconds, the drop has broken off and Fig. 9c shows the meniscus retracting into the nozzle as the bubble is in the final stage of collapse. (The free ink droplet was

not simulated in this particular study.) The bubble pressure is 1.3 atmospheres and its surface velocity is 10 m/s. (Numbers in the pressure field are pressure to the nearest atmosphere). Nozzle reflow produced by bubble collapse is seen clearly in the velocity field. Stability of the meniscus during bubble collapse is important to prevent trapping air in the nozzle.

The volume and curvature of the nozzle meniscus determine refill time (and maximum ejection frequency) because surface tension provides the pressure differential to draw ink from the reservoir. The volume of ink required is equal to the volume of air drawn in by the reentrant meniscus and this volume is larger than that of the ejected droplet by the volume of fluid forced down the refill channel during bubble lifetime. This fluid is stored temporarily in the per-

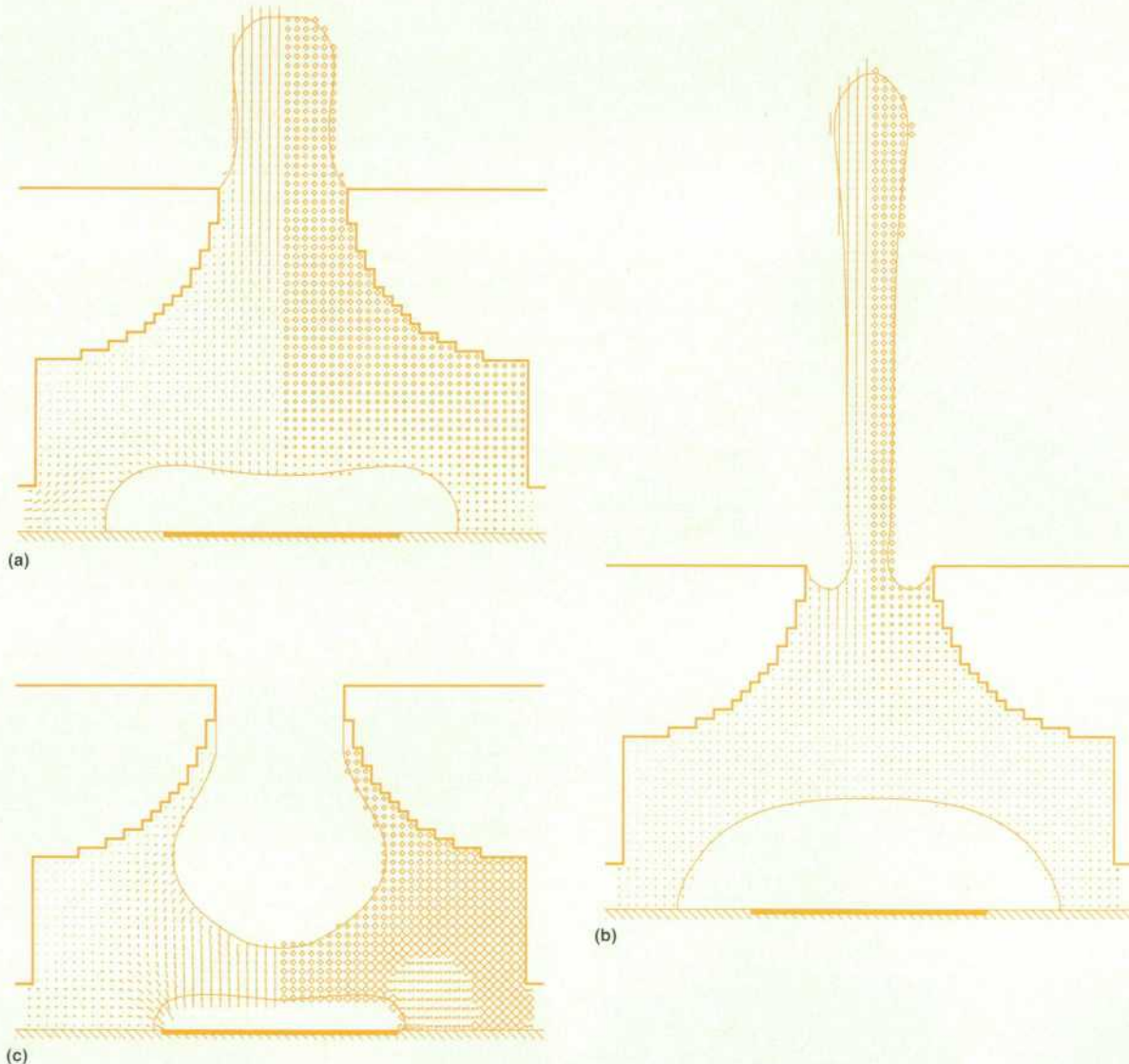

Fig. 9. Simulation of ink droplet ejection through a converging nozzle. Streamer length in left half of each plot indicates magnitude and direction of fluid velocity (one cell length = 10 m/s). The right half of each plot indicates pressure with symbols whose size corresponds to the pressure. (a) Five microseconds after bubble formation. (b) Fifteen microseconds. The bubble is beginning to collapse. (c) Twenty-four microseconds. The droplet has been ejected upward (not shown) and the bubble is in the final stage of collapse.

turbed menisci of neighboring nozzles, and may create crosstalk problems unless consideration is given to ejection order, timing, and layout of the nozzle pattern.

Conclusion

The complexity of the physical processes underlying ThinkJet technology required sophisticated modeling and computer simulations to develop design rules and to relate experimental observations to underlying physical causes. The complementary interaction of analysis and experiment

was essential to bring the thermal ink jet from invention to a practical technology.

Acknowledgments

The authors express their appreciation to the staff of the HP Computer Research Center and Bob Moody of the HP Scientific Computer Center for making their resources available during the development and use of the numerical simulations.

Development of the Thin-Film Structure for the ThinkJet Printhead

by Eldurkar V. Bhaskar and J. Stephen Aden

THE DISPOSABLE PRINthead (Fig. 1) used in the ThinkJet Printer consists of a glass substrate sandwiched with a nickel manifold containing twelve microscopic nozzles and mounted on a plastic body, which carries the ink supply. Each nozzle can supply ink on demand from the printer as the printhead scans across the paper. The droplets of ink are ejected by instantaneously vaporizing a tiny volume of ink. The vapor bubble grows rapidly and gives momentum to the ink above the bubble, which in turn is propelled through the nozzle onto the paper. Ink is refilled automatically to the nozzle area by capillary action.

An enlarged cross-sectional view of the ThinkJet printhead through a single nozzle is shown in Fig. 2. The printhead resistor structure for thermally exciting the ink ejection is fabricated on a glass substrate using standard IC processing techniques. Fig. 3 shows a flow chart of the processing steps. A dielectric material such as sputtered silicon dioxide is deposited first on the glass substrate as a barrier film to prevent leaching of impurities from the glass into the resistor and conductor films. The resistor film is tantalum-aluminum and is magnetron sputter deposited. Aluminum doped with a small percentage of copper is deposited next by magnetron sputtering to form the conductor film. The resistor-conductor films are photolithographically patterned to form a single column of 12 resistors connected by a common conductor on one end and terminated by 12 individual pads (terminals) on their other ends. The resistors are covered with ink-resistant passivation films. A polyimide coating further protects the passivation and the underlying thin films from degradation by the ink. To improve contact reliability, the aluminum pads are coated with nickel and gold films.

An electroformed nickel plate with twelve nozzles is attached to the thin-film substrate such that the orifices are aligned with respect to the resistors and a capillary

cavity exists between each orifice and resistor. To print a dot, the selected resistor is energized by a suitable electrical pulse and heated to several hundred degrees Celsius in a few microseconds. The ink-vapor bubble formed adjacent to the resistor propels an ink droplet out of the nozzle to form a dot on the paper. After the electrical pulse is turned off, the vapor bubble collapses, subjecting the thin-film passivation to severe hydraulic forces. During the operation and life of the printhead, the passivation experiences severe electrical, thermal, mechanical, and chemical stresses. Developing a passivation film for these exacting requirements presented some interesting challenges.

Material Selection

Several different materials were tried out as the passiva-

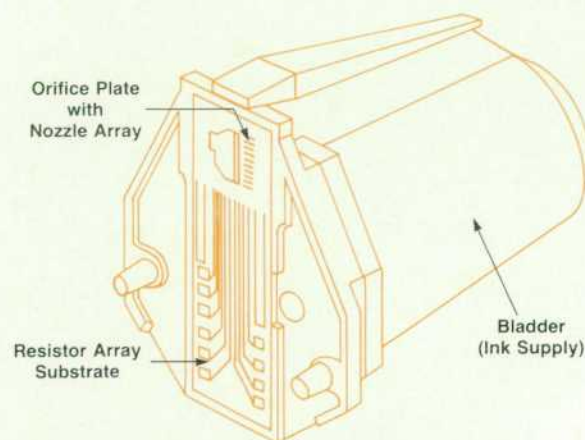

Fig. 1. The disposable ThinkJet printhead cartridge contains 12 thin-film resistors and mating ink-jet nozzles arranged in a vertical column and supplied by a rubber bladder filled with ink.

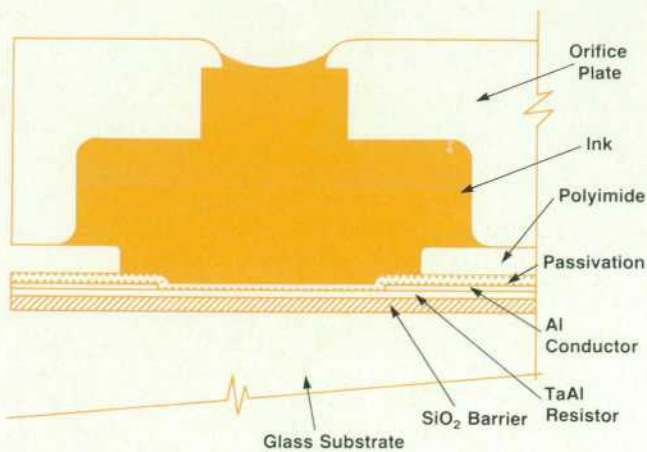

Fig. 2. Cross section of a single ThinkJet printhead nozzle and thin-film resistor structure.

tion layer for the ThinkJet printhead. Sputtered aluminum oxide was the first material tried, based on HP's previous thermal printhead experience. But the resistors would open up and fail within a few hundred thousand cycles of operation. The resistor failures were mainly caused by the large number of pinholes in the passivation and poor step coverage over the aluminum conductor edge. Also, over the long term the aluminum oxide was prone to chemical attack from the ink. A thin metallic coating over the aluminum oxide increased the life of some of the printheads to tens of millions of cycles of operation. But the repeatability of the process was poor because of the excessive number of pinholes (30 to 100/cm²) inherent in a sputtered-down dielectric such as the aluminum oxide film. Silicon carbide, being mechanically hard and chemically inert, was the next choice.^{1,2} In view of the inherent problems mentioned above for RF sputtered-down processing, a plasma enhanced chemical vapor deposition (PECVD) process, which is a potentially low-particulate process, was explored for depositing the silicon-carbide films.

The resistivity of the semiconducting silicon-carbide films deposited by the PECVD process is low compared to that of dielectric films. Hence, at the high operating temperature of the ThinkJet printhead, silicon-carbide films could provide a parallel path for the electrical current. This indeed occurred on heads passivated only with silicon-carbide film; this was determined by observing anodization of the film in the presence of ink and voltage on the resistor. Therefore, a double-layer passivation scheme consisting of insulating films such as silicon dioxide, silicon nitride, silicon oxynitride, and chemically inert films such as silicon carbide, each deposited by various techniques, was investigated. As a result of this experiment, a PECVD silicon nitride and silicon carbide combination was found to be optimal in terms of low operating voltage and long life of the printhead.

Process Characterization

Having found the optimum combination of thin films for passivation, the deposition process needed to be optimized for manufacturing printheads on a production scale with

acceptable yields and reliability. The PECVD process is used for the following reasons:

- Silicon carbide and silicon nitride films of any desired composition can be deposited by suitably varying the deposition conditions
- Higher throughput than the magnetron sputtering process
- Demonstrated low pinhole count and conformal coatings as an IC passivation process
- Only low-temperature process suitable for glass substrates and available for depositing silicon-carbide films of desirable properties.

In the beginning, some process refinement was necessary. Although the PECVD process has been widely accepted in the IC industry for depositing passivation and intermediate dielectric layers, it has been used only on silicon substrates.³ Substantial changes in the process and hardware were required for the ThinkJet printhead because of the use of glass substrates.

It was observed that silicon carbide films deposited at higher temperatures were superior to those deposited at lower temperatures in thermal and mechanical properties. This may be explained by the fact that the films deposited at a lower temperature include more hydrogen. The deposition temperature was fixed, and the other deposition parameters such as power, total flow, and flow ratio of reactant gases were then optimized using factorial design experiment techniques.⁴

After optimizing the deposition process for the two films, a full factorial experiment with star and center points using silicon-carbide and silicon-nitride thicknesses as the two variables was performed to identify the thickness ratio and total thickness of the two films. The dependent parameters

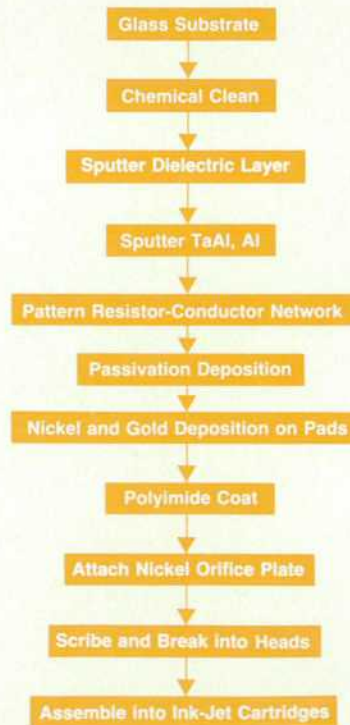

Fig. 3. Flow chart of basic printhead fabrication process.

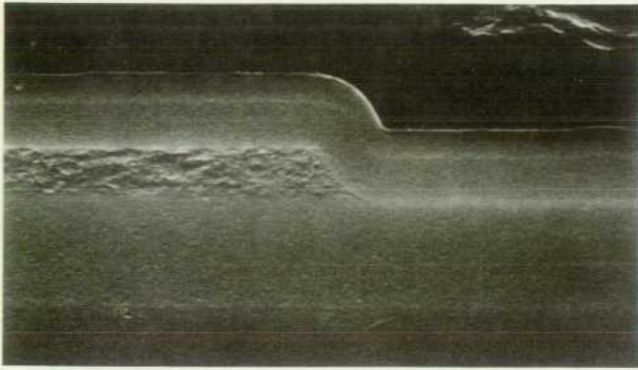

Fig. 4. SEM photomicrograph of cross section of the thin-film resistor-conductor structure.

examined were operating voltage, life, pinhole density and step coverage of the films.

The operating voltage and life were measured on finished printheads fabricated from the different runs of this experiment. Printheads from the center of the substrate were precision cross-sectioned, examined, and photographed in a scanning electron microscope (SEM). A typical SEM picture, as shown in Fig. 4, indicates good step coverage and conformal silicon-nitride and silicon-carbide films over the aluminum conductor edge. Pinhole density was measured on the substrates and is plotted in Fig. 5 versus passivation thickness. As one would expect, the pinhole density falls off rather dramatically with increasing passivation thickness. Operating life was determined by testing a sample of ten printheads from each run at 128% of the operating voltage until a certain number of failures occurred. Weibull analysis⁴ of the failure data gave a probability of survival up to 2 million cycles of operation, which is the required life of the printhead. Fig. 6 shows plots of probability of survival at 2 million cycles versus silicon-nitride thickness with silicon-carbide thickness as the third parameter.

Thin-Film Passivation Enhancement

Thermal ink-jet technology imposes a series of very harsh constraints on the choice of materials throughout the ink-jet

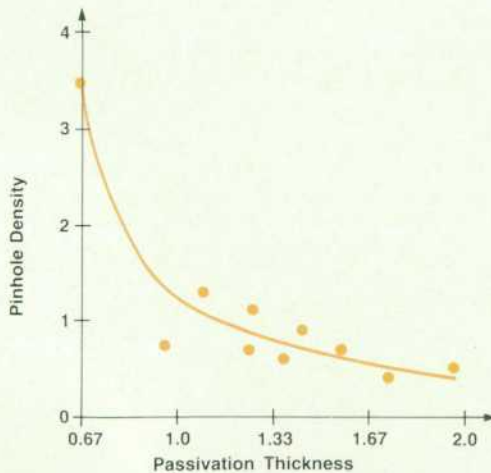

Fig. 5. Pinhole density versus passivation layer thickness. (Scales are normalized to nominal values.)

printhead. Perhaps one of the more formidable problems is providing reliable passivation of the thin-film resistor array which must operate while in direct contact with liquid ink. The dyes used in the ink contribute ionic contaminants that make the ink an effective electrolyte. As mentioned earlier, the thin-film circuit must be physically, chemically, and electrically isolated from the ink to provide processing flexibility without imposing too many constraints on the thin-film materials set.

Proper ink bubble and droplet formation require very specific, well-controlled thermal characteristics as well as cavitation resistance and chemical inertness. The two-layer structure of silicon nitride and silicon carbide discussed above was developed to meet these requirements. Unfortunately, this structure has a small but finite defect density. Therefore, an additional redundant passivation process was added to enhance printhead process yield and lifetime.

Process yield is a direct function of the probability of a given printhead having zero defects in the ink-wetted area. This yield is an inverse exponential function of both defect density and ink-wetted area (see Fig. 7). As the plot illustrates, the yield is a very strong function of both factors. That is,

$$\% \text{ Yield} = 100 \exp(-DA)$$

where D = defect density and A = ink-wetted area.

The strategy used for the ThinkJet printhead was to minimize both the ink-wetted surface area of the circuit and the effective defect density over the resistors themselves. Both concepts are useful in reducing the probability of thin-film failure.

Precisely controlled thermal characteristics are only required of the passivation over the resistors. The rest of the ink-wetted area is covered with a redundant polyimide passivation, effectively reducing the wetted area by a factor of forty.

Polyimide has a number of very useful properties for this application. It has been proven to be an excellent conformal

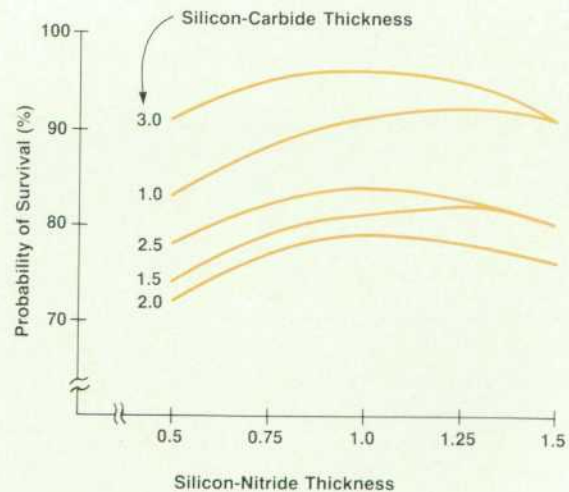

Fig. 6. Probability of printhead survival to two million cycles with 90% confidence as a function of silicon-carbide and silicon-nitride film thicknesses. (Thicknesses are normalized to nominal values.)

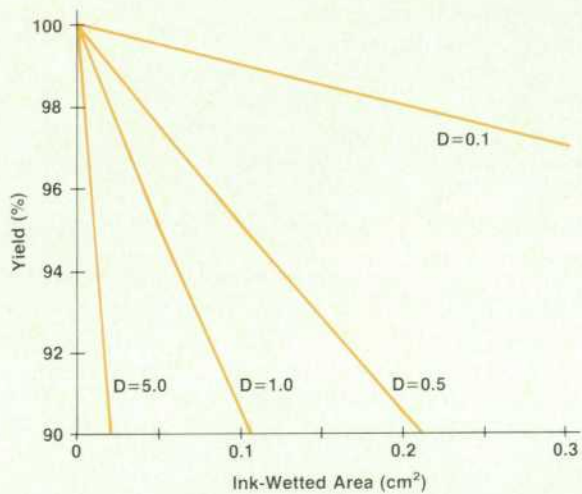

Fig. 7. Thin-film passivation reliability yield as related to ink-wetted area A and effective defect density D ($\#/cm^2$).

coating, giving good coverage over particles, metal steps, and voids. Since the material can be spin-coated in a wide variety of thicknesses up to $10\ \mu\text{m}$, it offers the fundamental advantage of being relatively insensitive to the defects that cause pinholes in the more conventional plasma-deposited films. The material is quite inert chemically and is both resilient and strong, giving good mechanical protection. Polyimide is also a stable dielectric under a variety of environmental conditions. One of the most important properties is that the material can be readily applied and processed with normal microelectronic photoresist techniques.

The primary process design goals were to build an effective redundant passivation process that would fit into the existing fabrication process in the simplest way possible. The initial process was therefore set up as a wet-etch, positive-photoresist process.

Early experiments showed that an organosilane adhesion promoter is required before spin-coating the polyimide to achieve reliable adhesion to silicon carbide. Positive photoresist is then applied and selectively exposed on top of the partially cured polyimide. The photoresist developing and

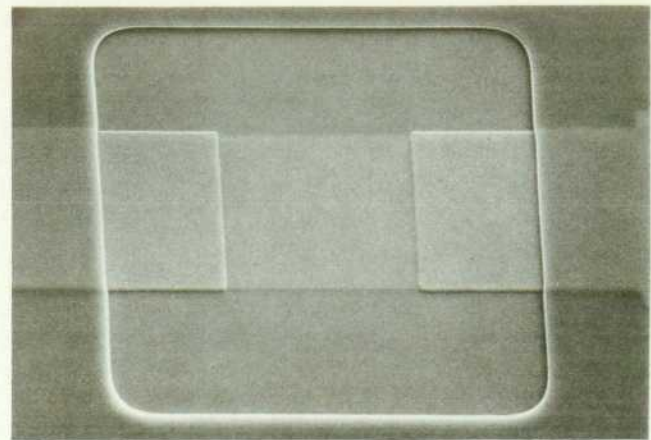

Fig. 8. SEM photomicrograph of thin-film resistor exposed through opening in the polyimide redundant passivation.

polyimide etching are done simultaneously in the photoresist developer. The resist is then removed in a simple, room-temperature solvent process. Finally, the film is cured in a high-temperature nitrogen bake.

The lateral dimensional constraints of $\pm 10\ \mu\text{m}$ for this level are so loose that they allow considerable overetching to minimize residues while avoiding endpoint detection difficulties common to wet processing. This conveniently provides smooth radiused corners without sharp discontinuities that could retain small gas bubbles near the resistors (see Fig. 8).

Considerably improved dimensional control has been obtained by using less overetching, but this usually requires an extra cleaning process, such as low-pressure oxygen plasma, to remove residues from the vias. Plasma etching of fully cured polyimide was also effective, but not required for this application.

The effective defect density includes a variety of defect types. Any type of defect that might allow ink to reach the thin-film metalization is considered to be a fatal defect. This includes pinholes intrinsic to the passivation, particulate inclusions, microcracks along conductor edges, and others. Optimization of the deposition process described

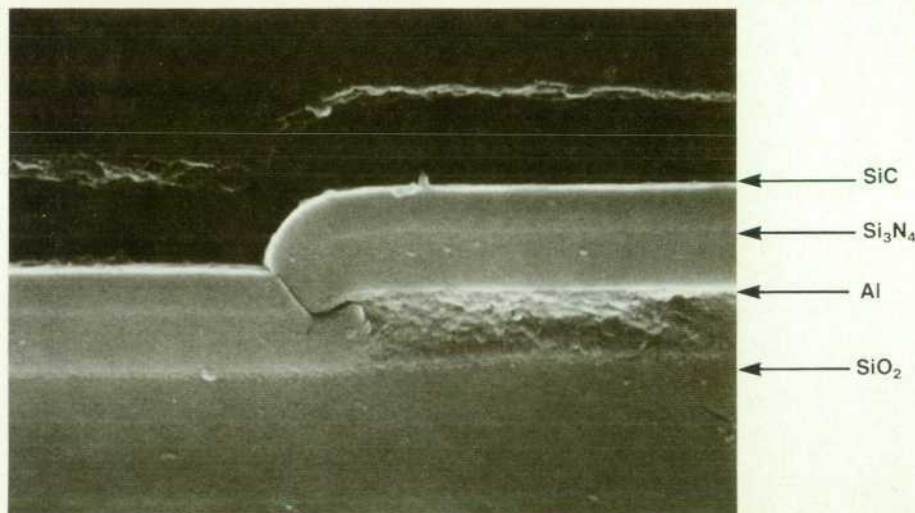

Fig. 9. SEM photomicrograph of passivation microcrack over the aluminum conductor.

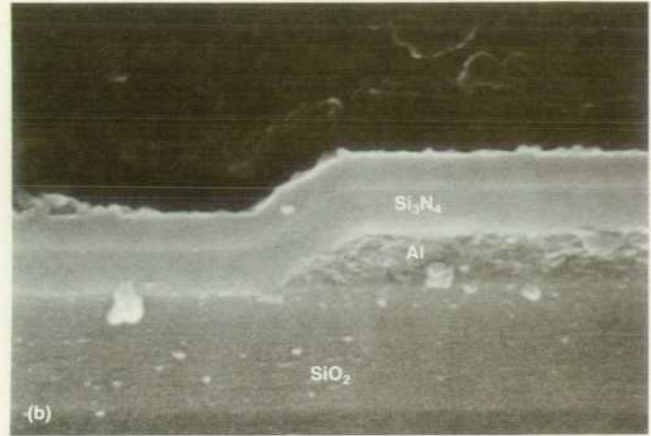
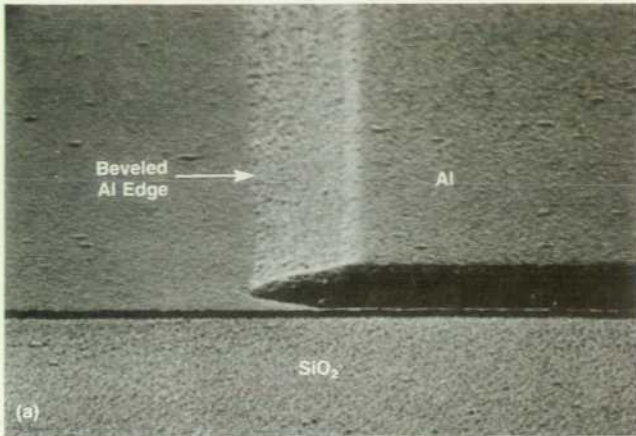

Fig. 10. (a) Beveled aluminum conductor edge before passivation. (b) Cross section of beveled aluminum conductor edge after passivation. Note absence of cusp formation at step.

above must address the first two types of defect, and to some extent, the third. It is interesting to note that, in spite of the large lateral dimensions involved, the film thicknesses required for rapid heat transfer make printhead reliability very sensitive to submicrometer particulate contamination.

The third type of passivation defect, microcracks along conductor edges, is of particular concern in this technology. The high-temperature thermal cycling of the resistors results in large temperature gradients and stress buildup along the resistor conductor boundaries. Any abrupt slope discontinuity in the passivation at this edge is likely to cause a failure (see Fig. 9). To avoid this, the aluminum

conductor edges are beveled to improve the subsequent step coverage (see Fig. 10).

This beveling is difficult to control, and is very sensitive to surface quality, materials, and process variations. The greater the beveling effect desired, the more difficult critical dimension control becomes. Fortunately, with lateral dimensions in the 100- μm range, the control requirements still allow the use of this technique in a wet-chemical etching process.

Using a redundant passivation coating to reduce the ink-wetted area to a minimum and beveling conductor edges to reduce effective defect densities are both done to provide process latitude. Reliability is a statistical concept that de-

(continued on page 33)

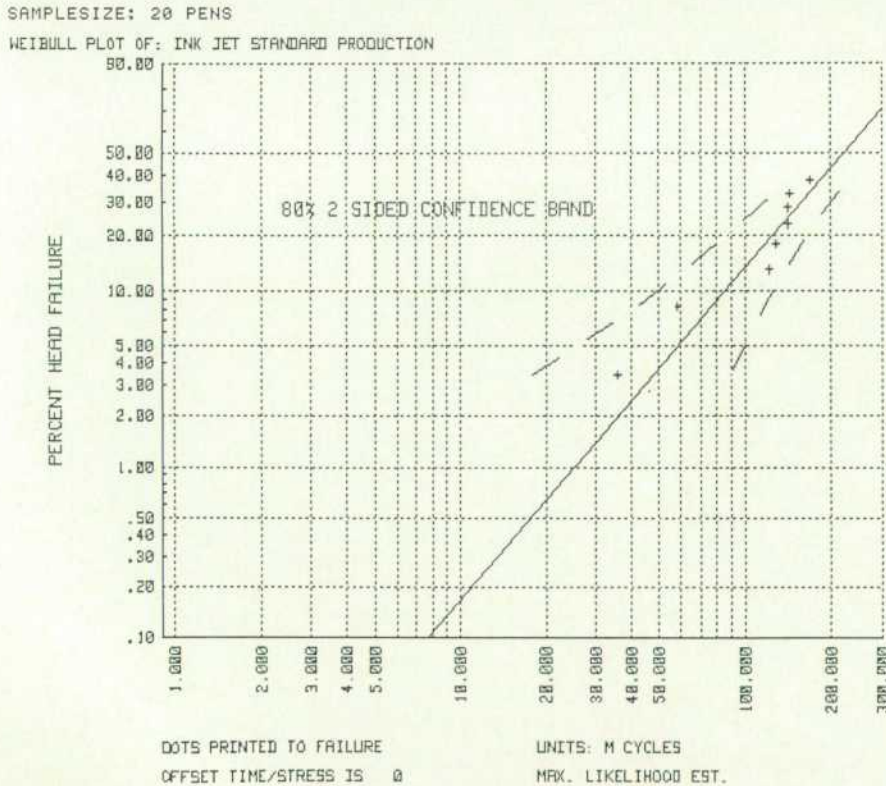

Fig. 11. Weibull plot of sample taken from standard ThinkJet print-head production.

Where the Ink Hits the Paper...

To operate in the ThinkJet printhead, the ink must be able to withstand a rather extreme temperature excursion of well over 300 degrees Celsius. Another requirement is complete lack of clogging of the ink-jet orifices for the entire lifetime of the printhead cartridge. Next, the system must print legible, dark print over the entire operating temperature of the printer. To avoid decomposition of the materials of the cartridge during long-term storage, analysis and reduction of the ink's corrosiveness and chemical reactivity to the printhead components was necessary.

Initially, it was expected that some commercially available inks would be acceptable. After some testing, however, it was determined that a key to the success of this product would be to develop an ink internally. Along with the above-mentioned requirements, experimentation determined that variations in the surface tension and viscosity of the ink played a great role in the ink droplet volume and velocity. Much of the initial testing of the ink-jet technology had been performed with standard fountain-pen ink. This provided a starting point for ink development.

In a fountain pen, the tip is coated with a very hard, noncorroding substance. This allows the ink to be corrosive and not destroy the print quality. In addition, the cap of a fountain pen provides retention of a solvent-saturated atmosphere that inhibits drying of the ink between uses. Because of space limitations, this approach is not available to the ThinkJet printhead cartridge.

Analysis of the corrosive nature of inks led the team to conclude that by decreasing the electrochemical activity of the ink, one could increase the lifetime of the printhead. The activity of any solvent-solute system is determined by the ionic strength, the mobility of the ions, and their reactivity. Each of these three chemical mechanisms was altered to allow a less-reactive product. To decrease the activity, all unneeded ionic materials were removed. The mobility issue was addressed by increasing the size of the ions as well as changing the solvent to a more viscous material. Reactivity was decreased by choosing less reactive chemical ions.

The second item pursued was minimizing the drying-out problem. Precipitation of the ink colorant in the printhead orifices was determined to be the cause of the clogging problem seen in the use of fountain-pen ink. By adding a low-vapor-pressure solvent in which the colorant is still soluble to the basic ink solvent, the ink in the orifice becomes a different chemical composition from that in the main chamber. This additive has a very high viscosity in its pure state, which reduces the rate of evaporation of the basic lower-boiling-point solvent as its concentration decreases. Since the colorant is soluble, and eventually no more of the basic solvent escapes, a "liquid plug" forms in the orifice. Upon the first printing after a long span of rest, the printhead easily ejects this liquid plug.

Another requirement is to pass the solution through a 1-micrometer filter to remove material that might easily clog the orifices. In the chemical makeup of the ink, filtering is done quite frequently, and considerable care is used to avoid contamination further along in the production of the printhead cartridge.

Kogation is defined as the plaque buildup found on the resistors of a thermal ink-jet head after several firings of the system (see Fig. 1). It can cause the head to fail by insulating the resistor from the ink supply, which reduces bubble generation. The major source of kogation is the ink. By modifying the ink material appropriately, kogation can be varied from rapid buildup to excessive erosion. In the ThinkJet ink, formulas have been optimized to provide a very slow buildup of plaque.

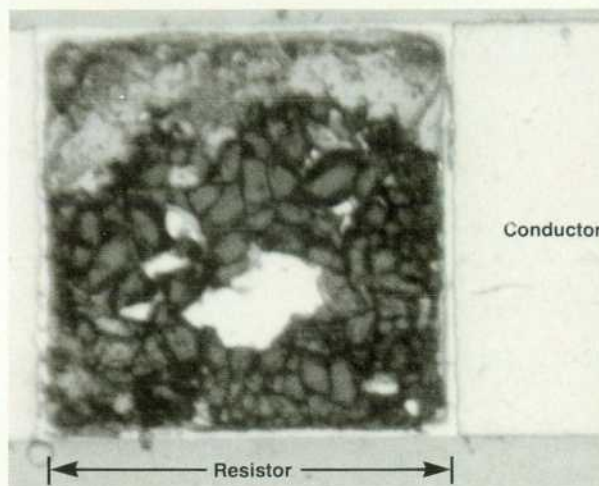

Fig. 1. Microphotograph of kogation—the buildup of decomposed ink on the resistor surface.

Volume

During the initial prototype era of ink manufacture at HP, volumes of 1 to 10 liters were produced at a time. At the onset of production, to fill the needs of the many ThinkJet printhead cartridges, we now manufacture ink in 500-liter batches. Analysis of the components of the ink by UV-visible spectrophotometry with an HP 8450A Spectrophotometer allows the direct storage of the spectra on magnetic disc media. An HP 1081B Liquid Chromatograph is used to monitor the specific concentrations of the multicomponent ink. Finally, viscosity, conductivity, surface tension, specific ion concentration, and pH are all recorded and checked for control. From every batch, an archived sample is retained in addition to the computer-stored parameters to allow complete traceability of the ink from any printhead cartridge produced by HP by noting the serial number embossed on it.

Acknowledgments

Development of the ink to use in the ThinkJet printhead was performed by a small team of engineers at five separate locations within HP. Of special note, John Rhodes, Bob Miller, Loren Johnson, and Sam Judd of HP's Vancouver Division were the development team. From the Corvallis Division, Curt Sheley, Niels Nielsen, and Frank Cloutier were involved, and Don Palmer, Adrienne Meuter, and Ron Selensky of the San Diego Division, which makes pens to support the HP plotters manufactured there, offered their advice. Bill Lloyd, Howard Taub, and Lucy Thach of HP Laboratories and Jim Bearss of HP's Boise Division also aided the development of the ink.

David Hackleman
Project Manager
Ink-Jet Components Operation

depends on many factors. High-reliability ink-jet heads can be built without these enhancements, but high-volume, low-cost production inevitably involves variation of many parameters. It is very useful to build process latitude into the fundamental design of any device. In a very real sense, latitude is reliability.

Sustaining the passivation process through production brought out the importance of regular cleaning of the process chamber and hardware, proper precleaning of substrates, and operating a "clean" process, and the need for process monitors such as pinhole monitors and the thickness monitor to yield a reliable ThinkJet printhead. A life test is performed on a regular basis on a sample of twenty printheads drawn from production assembly. A typical Weibull plot of failures from such a life test to 200 million cycles is shown in Fig. 11. It can be seen from this Weibull plot that the predicted life of this lot with 95% probability of survival with 90% confidence is 25 million cycles, which is much greater than 2 million cycles—the required life of the pen to print 500 pages. Said another way, the predicted reliability with 90% confidence at 2 million cycles is 99.2%.

Acknowledgments

A project of this dimension has many contributors. The

authors would especially like to thank everyone in ink-jet R&D and production for their cooperation and support. Mike Angerstein and Ron Enck performed most of the experiments and contributed heavily in ideas, suggestions, and hard work in this development. The physical analysis laboratory at HP's Corvallis Division provided excellent support in AES analysis, cross-sectioning, and SEM examination.

This investigation and process development would not have been possible without the consultation of Marzio Leban of the Ink-Jet Components Operation at HP's Corvallis Division.

References

1. D.A. Anderson and W.E. Spear, "Electrical and Optical Properties of Amorphous Silicon Carbide, Etc.," *Philosophy Magazine*, Vol. 35, no. 1, 1977, p. 1a.
2. M.H. Lee, et al, "Electrochemical Tests to Evaluate Passivation Layers: Overcoats of SiC in Ink," *Journal of the Electrochemical Society*, Vol. 129, no.10, October 1982, p. 2174.
3. W. Kern and R.S. Rosler, "Advances in deposition process for passivation films," *Journal of Vacuum Science & Technology*, Vol. 14, no. 5, September-October 1977, p. 1082.
4. C. Lipson and N.J. Sheth, *Statistical Design and Analysis of Engineering Experiments*, McGraw-Hill, 1973.

The ThinkJet Orifice Plate: A Part With Many Functions

by Gary L. Siewell, William R. Boucher, and Paul H. McClelland

WHEN THE SUPERHEATED INK over the energized thin-film resistor in the ThinkJet printhead explodes into a vapor bubble, ink is forced outward in all directions. The orifice plate has the task of directing this fluid flow into a drop traveling toward an exact spot on a sheet of paper.

The orifice plate controls drop size and trajectory. It has a strong influence on drop velocity. It facilitates the flow of ink from the reservoir to the nozzle (refill). It contains the turbulent fluid flow and inhibits ejection from adjacent nozzles (crosstalk). The orifice plate (Fig. 1) is special in that it achieves all of this in a single nickel electroforming step (see box on page 35 for brief description of electroforming).

The nozzles are formed around a pillar of photoresist with a very carefully controlled overplating process, which helps determine the appropriate nozzle diameter to control drop size and velocity. On each side of each nozzle are barriers (see Fig. 2) that, when the orifice plate is bonded to the thin-film substrate, form walls down to the surface of the substrate. These barriers help inhibit adjacent nozzles from ejecting spurious drops of ink when a nozzle is

energized by preventing direct fluid flow from one nozzle area to another.

A manifold shaped like the outline of a grand piano rises above the ink fill hole in the underlying thin-film substrate and extends to the nozzles, allowing ink to flow easily for maximum print rate. Slots are positioned just outside the ends of the barriers to act as fluid flow shock absorbers, preventing fluid flow pulses from ejecting ink from other nozzles and venting any gas bubbles that might be ingested during collapse of the main vapor bubble. Standoffs drop down to the substrate surface at several points and, along with the barriers, establish the critical capillary spacing. These features must be achieved with near semiconductor precision and they are done with multicelled mandrels, which allow the high volume and low costs necessary for a disposable printhead.

Engineering Challenges

What were the challenges? The design, of course, was a challenge since most of the design evolved as painstaking solutions to problems of print quality. As always, the first law of development, the conservation of problems, was

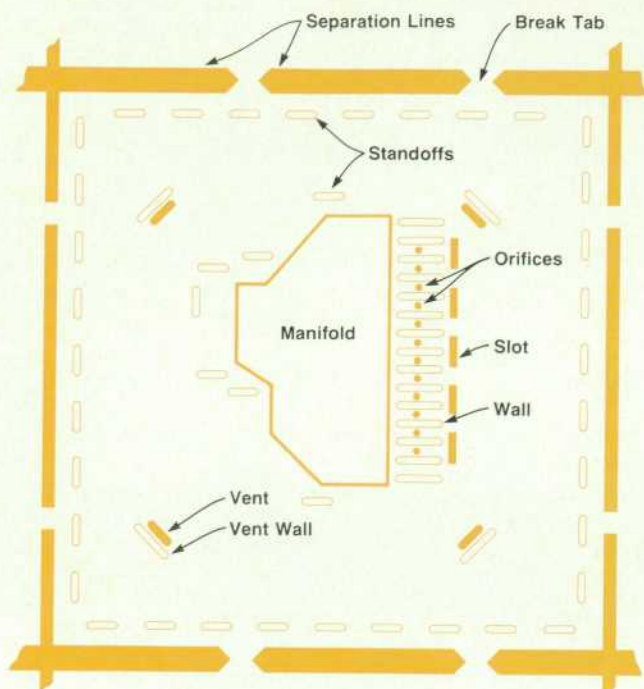

Fig. 1. Layout of the ThinkJet printhead's orifice plate. This electroformed piece is bonded to a thin-film resistor substrate to form a high-performance ink-jet printing unit that can be made inexpensively enough to be disposable after printing the equivalent of 500 pages of text.

present. It seemed that just as one problem was nearly solved another was discovered. We also experienced the paradox to this law which can be stated, "If N more engineers are assigned to the project, they will unearth problems that would have not otherwise have been discovered, at a rate proportional to $N + 1$, such that the schedule will not be significantly impacted."

However, the real challenges were making parts that met the critical dimension tolerances, making parts that met the volume requirements, and making parts at reasonable yields (low cost).

Mandrel

Following the process flow, the raw material for the mandrel must be:

- Capable of being etched with precision
- Capable of being plated with nickel with the exact adhesion so that delamination during electroforming is prevented, but the finished electroform is released without deformation when desired
- Durable enough to maintain shape and finish through at least fifty platings
- Readily available.

The material chosen is thin stainless steel, which can be pulled flat on a vacuum chuck for precise photolithography.

The preparation of the stainless steel mandrel is outlined in Fig. 3. After the mandrel plate is deburred, burnished, and cleaned, a layer of photoresist is spun on the surface and patterned to form protected areas where the manifolds are desired. Then, the exposed surface area is etched to

the specified depth. The challenge here is to etch the entire surface uniformly so that the subsequent barrier etch can be done precisely.

The resist is removed and the mandrel is burnished and cleaned again. A new coat of photoresist is spun on and patterned to define the barriers and standoffs, which are then etched. Each mandrel measures 7×7 inches and contains 3300 barriers and 2400 standoffs to make 240 potential printheads per electroformed sheet.

The surface finish of the orifice plate is controlled by the mechanical burnishing operations between the mandrel etch steps. This mechanical surface finishing is important for a smooth barrier etch, adhesion of the electroform during plating, and adhesion of the photoresist used for the nozzles and parts separation. Etched and burnished mandrels have been used over 100 times and it appears that the only mode of failure will be mishandling rather than wear.

Orifice Plate

The electroforming process for the orifice plate is outlined in Fig. 4. The steps are:

- The stainless steel mandrel is laminated with dry film photoresist.
- The resist is exposed and developed so that circular pads, or pillars, are left where the orifices, or nozzles, are desired.
- The mandrel is electroplated with nickel. The photoresist serves as a mask for the plating and nickel is deposited only on the exposed stainless steel areas, including the insides of the grooves etched into the mandrel to define the barrier walls and standoffs.
- The plating is peeled from the mandrel. Since stainless steel has an oxide surface, plated metals only weakly adhere to it. Thus, the electroplated film can be removed easily without damage.
- The photoresist is stripped from the nickel foil.

The nickel foil (see Fig. 5), or electroform, now has openings wherever the resist was on the mandrel. The resist is also used to define the edges of an orifice plate, including break tabs. This allows a large number of orifice plates to

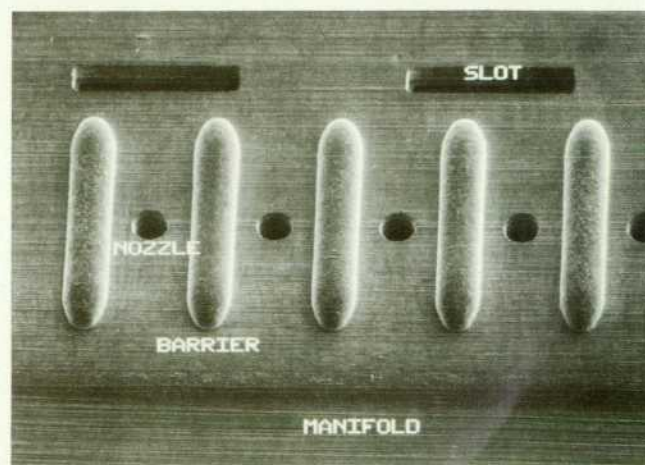

Fig. 2. Scanning electron microscope photomicrograph of nozzle and barrier wall section of orifice plate.

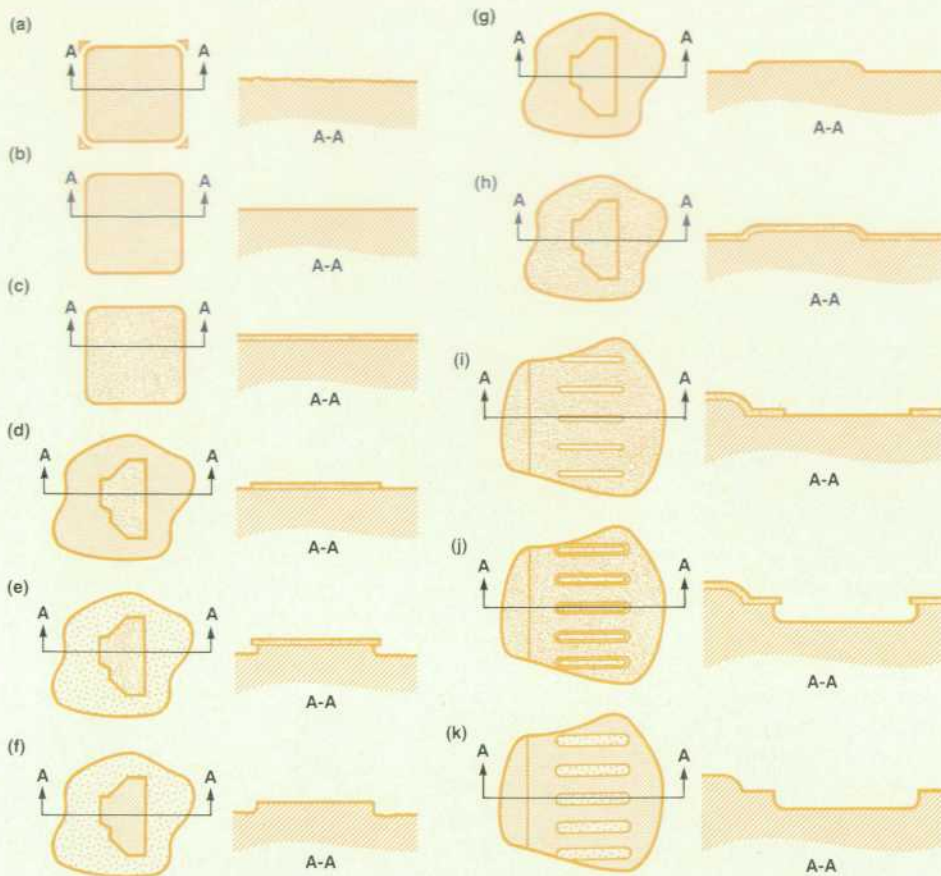
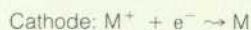
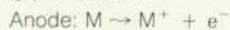

Fig. 3. Mandrel fabrication process. (a) Round corners and deburr edges of the stainless steel plate. (b) Burnish the surface. (c) Clean surface and spin on positive photoresist. (d) Expose and develop photoresist to define manifold areas. (e) Etch surface of exposed stainless steel. (f) Strip photoresist. (g) Burnish surface to round edges of raised manifold areas. (h) Clean surface and spin on a new coat of positive photoresist. (i) Expose and develop photoresist to define barrier wall and standoff etch areas. (j) Etch barrier wall and standoff trenches. (k) Strip photoresist. Mandrel is now ready for electroforming orifice plates.

Electroforming

Electroforming is more commonly known as an adaptation of electroplating. Most of us are familiar with electroplated items such as jewelry, car bumpers, plumbing fixtures, and the printed circuit boards used in our televisions, radios, etc. The electroplating is accomplished by placing the part to be plated in a tank that contains the plating solution and an anode (see Fig. 1). The plating solution contains ions of the metal to be plated on the part and the anode is a piece of that same metal. The part being plated is called the cathode. Direct current is then applied between the anode and cathode, which causes the metal ions in the solution to move toward the cathode and deposit on it. The anode dissolves at the same rate that the metal is being deposited on the cathode. This system is called an electroplating cell.

At the anode, the metal atoms lose electrons and go into the plating solution as cations. At the cathode, the reverse happens, the metal ions in the plating solution pick up electrons from the cathode and deposit themselves there as a metallic coating. The chemical reactions at the anode and cathode, where M represents the metal being plated, are:



Electroforming is similar to electroplating, but there is a twist. An object is electroplated with a metal, but the plating is then separated from the object. The plating itself is the finished product and in most cases, the object, or mandrel, can be reused many times. The removed plating retains the basic shape of the

mandrel and, in fact, exactly replicates it on the side that contacted the mandrel. Examples of electroformed items are electric razor screens and stamping dies for records. Even the rocket nozzles on NASA's space shuttle are manufactured in this way.

The advantages that electroforming offers are:

- The accurate reproduction of fine details (record stamping dies)
- The ability to form complex shapes out of a single piece of material (rocket nozzles, intake scoops for jet aircraft)
- Significantly reduced manufacturing costs because the effort put into the finely detailed mandrel can be amortized over the many parts that can be formed with a single mandrel.

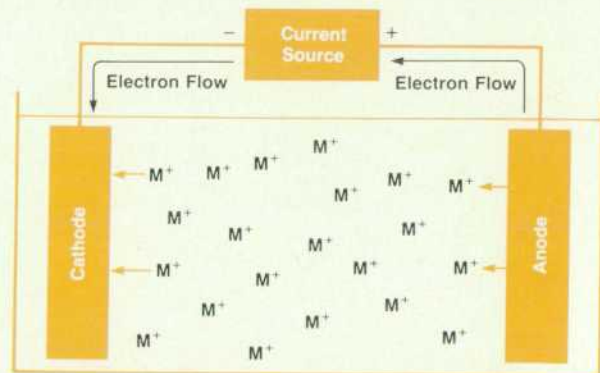

Fig. 1. Basic electroplating cell.

be formed on one mandrel, removed in a single piece, and then separated into individual printheads later after the piece is bonded to a mating array of thin-film substrates.

As mentioned above, the nozzles, the shock absorber slots, the corner vents, and the break tabs are all defined by photoresist images developed on the etched stainless steel mandrels. The mandrels are currently electroplated, six at a time, in a modified Watts' type (sulfate-chloride) mixed anion bath nickel-plating process. The most critical parameter for the electroform is the nozzle exit (bore) diameter. This follows another oft observed development law: "The difficulty of achieving a dimension in a component is an exponential function of its importance to performance." The nozzle is formed by allowing the nickel to plate up partially over the top of the photoresist pillar that defines the nozzle so that the exit diameter is 10 to 20 μm smaller than the pillar diameter. The trick is to get all of the pillars in an electroforming batch (six mandrels) to overplate the same precise amount at the same time and to know when this moment occurs. This requires balancing resist thickness, pillar diameter, plating thickness, and overplate ratio.

Other significant parameters for the orifice plate are ductility, internal stress, and corrosion resistance. Internal stress and ductility affect the manufacturing process more than the performance factors since the parts are attached

to the thin-film substrate in strips. If the ductility is too low the parts will fall apart before assembly, and if it is too high, the strips will not separate with a simple bend in the automated equipment. Internal stress affects the length of the strip, which in turn affects resistor-to-nozzle alignment across the assembly, and can affect the capillary space if allowed to get out of the control band. Fortunately, several parameters of the plating cell can be monitored and adjusted to control overplate ratio, ductility, surface finish on the solution side of the electroform, and internal stress.

The corrosion resistance of the orifice plate as demonstrated in the production printhead is dependent upon two parameters: ink chemistry (see box on page 32) and the building of a hydrated oxide layer on the nickel surface. In the present process, it is the soft mandrel (resist) stripping steps that build this oxide layer. At room temperature with production inks, it has been demonstrated that the nickel corrosion is less than 1 μm per year—quite acceptable for a structure intended for use in a disposable printhead.

Process Control

As production passes the 100,000 printheads per month level, the crucial step proves over and over again to be process control. No matter if it is a simple design or a sophisticated design, production implementation without

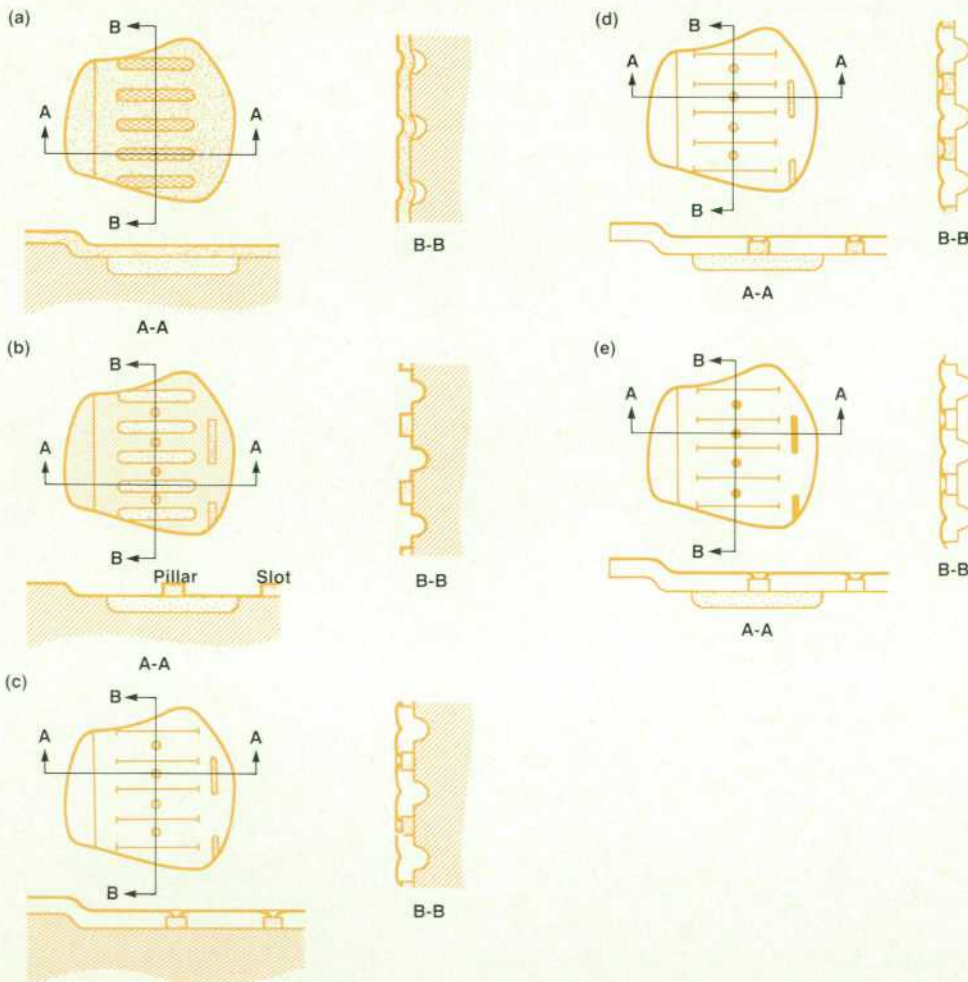

Fig. 4. Orifice plate electroforming process. (a) Laminate dry photoresist film onto mandrel. (b) Expose and develop resist to define areas where orifices and slots are required in the orifice plate. (c) Electroplate the mandrel with nickel to a thickness where a small amount of nickel overlaps the edges of the photoresist pattern. (d) Separate electroformed nickel layer from mandrel. (e) Strip photoresist. Orifice plate is ready for bonding to thin-film resistor substrates.

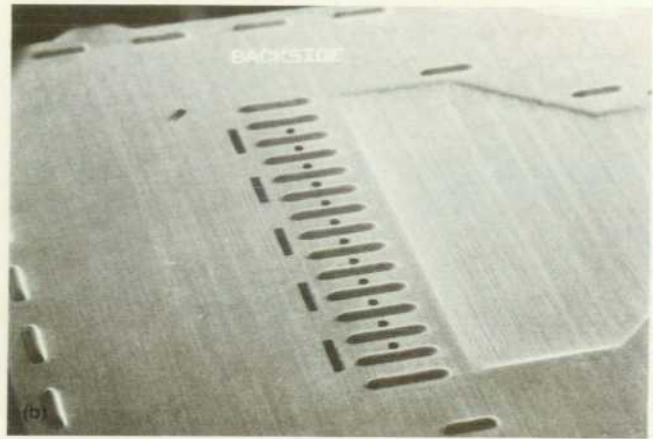
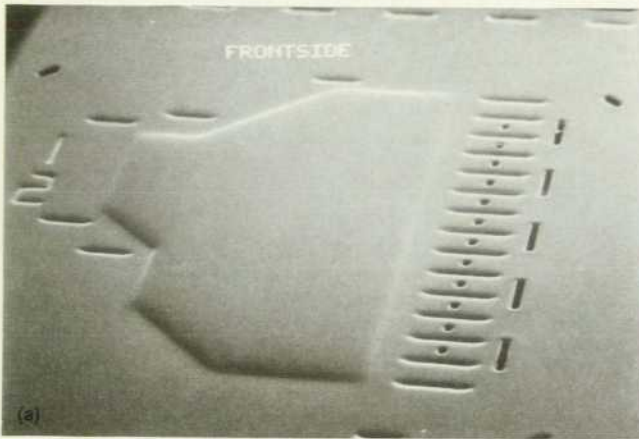

Fig. 5. Scanning electron microscope photomicrographs of front surface (a) and back surface (b) of orifice plate.

process control is a disaster waiting to happen. In fact, the orifice plate process as described should not and will not yield adequately if one only looks at the variation in the raw materials plus the variation in the processes. However, with the concept of precontrol operating in the process cycle (see Fig. 6), production demonstrably operates in a predictable and cost-effective manner. Inspection and rapid closed-loop feedback are only part of the good practices that account for predictability. Besides the automated sampling and usage-defined "bleed-and-feed" solution makeup, production monitors and reacts to exposure light

intensity, developer breakpoint, developer titer, weight per orifice sheet, strip length, and bath analysis on a daily basis.

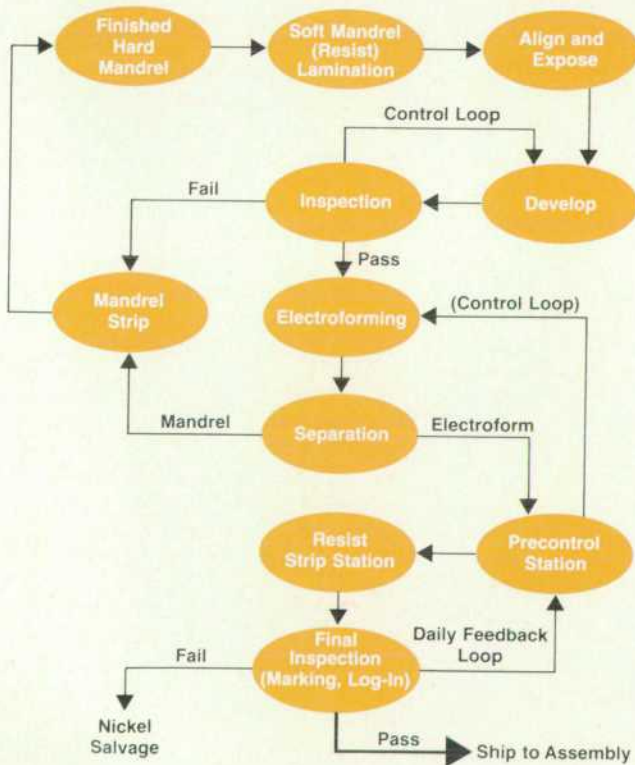

Fig. 6. Process flow with controls for fabricating ThinkJet orifice plates.

Managing the Development of a New Technology

by Frank L. Cloutier

IN OUR MODERN, HIGH-TECHNOLOGY ERA, we have become accustomed to announcements of "breakthrough" technologies. So much so in fact, that the absence of such announcements on a regular basis has signaled the maturity of a technology to virtually the point of obsolescence. Hewlett-Packard has played a crucial role in the initial development of several such technologies. One of the hard realities that HP learned in its pioneering efforts is that the invention and/or initial development of one of these "marvels of modern science" does not guarantee long-term commercial success in that arena. In fact, it is not clear that being first is even a major component in the long-term competitive viability of a high-technology endeavor.

These lessons have not been easily or cheaply learned, and they still are not universally understood or accepted. But, it was certainly with these lessons prevalent in our minds that we first viewed the opportunity that we had with what we have come to call HP's Thinkjet printer technology.

The fundamental idea of using a thin-film resistor to heat microscopic amounts of fluid to generate steam bubbles that would propel the fluid through a small channel came from John Vaught at HP Laboratories. It was almost immediately recognized as a very promising idea for advanced printing systems, because of the inherent fine resolutions that could be achieved with thin-film technologies. It seemed possible that several other performance problems that conventional ink-jet printing systems suffered from, like speed for a drop-on-demand system, total number of active nozzles, etc., might be alleviated, if not ultimately solved with this new approach.

The state of the technology had barely reached the point where single crudely built nozzles were firing discrete dots on business cards when a number of HP product divisions saw the potential of the investigation by HP Labs. Encouraged by a number of rapid early successes, we established considerable momentum toward developing the technology as a commercial reality.

It was about at that point when the expensive lessons of the past started to drive our entire development philosophy. We realized that even if we were extremely successful in squeezing adequate performance out of the new devices, we still would not have a sustainable competitive edge over others who have repeatedly demonstrated the ability to undercut the price of any technology dramatically, independent of its complexity.

There were other problems as well. Ink-jet devices had been poorly received until that time because of the messy nature of refilling bags, tubes, priming pumps, etc. We were determined to build what we called an invisible ink system—invisible not to the eye, but to the hand, shirt, etc.

Another potential problem was recognized early and subsequently verified. To make a device last long enough to be used for the life of a product, a considerable number of other performance parameters may have to be sacrificed. Indeed, many a would-be new technology has never made it out of the development lab because of reliability problems.

Finally, to achieve the economies of scale that we deemed necessary for appropriate manufacturing methodology and automation,

we would have to produce an enormous volume of devices. This was a key element in our ability to compete with outside sources.

With this mindset fully established, our options narrowed considerably. Someone came up with the radical idea of actually making the entire printhead unit self-contained and disposable. It was one of those ideas that was at first laughed away, but remained and incubated in the backs of our minds. The incumbent manufacturing cost dictated by the idea seemed at first to be absurd. After all, this was an entirely new concept that was not necessarily destined for low-cost manufacturing. The turning point was the realization that we really did not have a choice in terms of the long-term competitive nature of the industry. This single decision forced us into several others, all of which mandated that we be extremely competitive—or else fail altogether.

With this new resolve (and our now tentative careers) in hand, we embarked on building not only a revolutionary new printing technology, but also an automated manufacturing center that would be second to none in the industry.

The emerging beauty of the disposable concept was evident also in its impact on the aforementioned problems. Now we had the promise of what would look to the customer as a solid-state device—as close to an invisible ink system as we could probably get. Ink exchange was now done by replacing the entire print engine. The product interface was now only electrical and not fluidic. Head life, nozzle clogging, etc. did not pose the catastrophic threat to reliability that they did with conventional approaches. Head performance could be optimized without sacrificing extremely long product life. Manufacturing volumes would be proportional to the total installed product base, rather than one to one with the product. Significant advances in the technology and inks would not only enable enhancement of new products, but possibly could even be extended to give early customers better performance with new printheads.

HP was naturally eager to turn the new technology into a commercially viable product as soon as possible. Usually, given that the normal gestation time for a new technology like this is roughly five to ten years, products are not considered until the technological performance and manufacturing promise are well established. Another harsh lesson that we have learned is that product development cycles have to be shortened to remain competitive in a marketplace where the average half-life for a high-technology product is eighteen months. Given HP's uncompromising commitment to quality and performance, it was clear that an entirely new management and scheduling approach would have to be developed to meet our timing desires.

Within a few months of our initial investigation of the technology, we staffed a product effort. The risks were enormous, since at that time the simple viability of the technology had not been rigorously demonstrated! Our ability to manage an effort like this with traditional well-defined and unchangeable objective sets was clearly incompatible with the dynamic nature of the simultaneous invention and development of the technology that would be required.

Two major techniques evolved that proved absolutely crucial

to the success of the project. One was unrivaled communications between the product and the technology groups. The other was an extremely strong commitment to a true team approach, where the whole was clearly equal to more than the sum of the parts. The phrase "that's not my job" was sufficient grounds for termination from the project. With new and unanticipated problems and forced changes occurring on almost a daily basis, the entire group had to be ready to respond to "resets" on a moment's notice. The byword became flexibility. Decisions had to leave several alternative paths. As resets happened, we had to respond as a single force, with no internal "finger-pointing."

A delicate balance had to be struck between overpromising what the technology would be able to do and being overconservative. The latter approach would lead to a product that had a weak feature set, and the former would lead to no product at all.

Fortunately for HP, all of this philosophy of running a technology development as a business evolved very early in the ThinkJet development cycle. The manufacturing center was never built as a prototype facility and then scaled up for production. Most technologies go through several early phases before commitments are made for the enormous cost of outfitting clean rooms and ordering equipment and automated tooling. The risks were not quite as ominous as all this would normally imply. Since we had to make these decisions early, we also determined to be as opportunistic as possible by using existing expertise and resources within HP. In many cases, the fundamental design of potential

alternative processes was driven by existing equipment or expertise at HP's IC, liquid-crystal display, or thermal printhead facilities in Corvallis, Oregon.

Previously, we referred to a time in the early phases when "...encouraged by a number of rapid early successes, we established considerable momentum...." Murphy's Law always seems to be suspended at the beginning of a project, only to crop up with greater vigor once commitments have been made. This has never been more apparent than in this effort. Someone has said that the "ThinkJet technology is deceptively simple." That is the single biggest understatement since Noah said "It looks like rain."

In spite of these obstacles, the program was completed in one third to one half the time traditionally required for new technology and product development.

In summary, I have tried to give a glimpse into the birth pangs of developing a new technology as well as into the evolution of a new way of thinking about high technology as a long-term competitive business. HP is as committed to being a technology and performance leader as we have ever been—probably more so. But we have recognized that technology for the sake of technology does not impress our nonengineering customer base. Those customers are interested only in how a new technology allows them to do their tasks better and/or less expensively. That translates into bringing advances to them faster, at considerably less cost, and with the long-term commitment behind those technological advances that ensures continuing support and increased performance.

Authors

May 1985

4 ThinkJet Development

Niels J. Nielsen



A specialist in thermal ink-jet technologies, Niels Nielsen joined HP in 1979. He has worked in the areas of ink and pen design, printhead development, paper evaluation, ink testing, and ink reservoir and plastic part design. He is the author of papers on nondestructive inspection of surface topography and his work has resulted in one patent and two patent applications on concepts related to ink reservoir design. Niels was born in Hayward, California and attended the University of California at Davis from which he earned BSME and MSME degrees in materials science (1975 and 1979). He is an electric bass guitar enthusiast and worked as a semiprofessional musician before coming to HP. He lives in Corvallis, Oregon with his wife, who also works at HP as a technical writer. They are expecting a child later this year. He has a miniature recording studio in his home and makes occasional public performances. He says that hats are his trademark and he is never without one.

11 Inexpensive and Portable Printer

Thomas R. Braun



A section manager at HP's Vancouver Division, Tom Braun first came to HP in 1975. He has worked as an R&D engineer and as a project manager on the HP-97 Programmable Calculator, the HP 82143A Printer/Plotter, the HP 82161A Digital Cassette Drive, and the ThinkJet Printer. Tom was born in Covington, Kentucky and studied at the Massachusetts Institute of Technology, from which he received a BSEE degree in 1972 and an MSEE degree in 1975. He currently lives in Vancouver, Washington with his wife, who is also an HP engineer. He enjoys golf, softball, and dog training, and is interested in investment strategies.

Cheryl V. Katen



Cheryl Katen was born in Scranton, Pennsylvania and received a BS degree in plastics engineering from the University of Lowell in 1966 and an MS degree in industrial engineering from Colorado State University in 1976. Since coming to HP in

1972, she has worked as a manufacturing engineer, as a manufacturing manager, and as a quality manager. She was project manager for the mechanical aspects of the ThinkJet Printer development. She is the author of a number of articles for trade journals and conferences and is active in professional organizations, including the Society of Manufacturing Engineers. She also served for a term on the Oregon Electrical Advisory Board. Cheryl lives in Corvallis, Oregon with her husband and enjoys fly tying, beachcombing, and scuba diving. She recently rewarded herself with a diving trip to the Great Barrier Reef, Australia.

21 Thermodynamics and Hydrodynamics

William R. Knight



Bill Knight was born in Burbank, California and served as a sergeant in the U.S. Air Force. He was educated at the University of California at San Diego, from which he received BS and MS degrees in physics in 1976 and 1978. After coming to HP in 1979 he worked on the design and testing of liquid crystal displays and contributed to the development of thermal ink-jet technology. His work has resulted in two patents on heat engine concepts. Bill lives in Corvallis, Oregon, is married, and has one child.

Ross R. Allen

Before joining HP in 1981, Ross Allen was an assistant professor of engineering at the University of California at Los Angeles. At HP he has specialized in theoretical and experimental work on thermal ink-jet printers. A lifelong resident of California, he was educated at the University of California at Davis, from which he received a BSME degree in 1969, an MSME degree in 1971 and a PhD degree in 1975. He has published 16 articles on dynamic system analysis, modeling, and simulation. He is married and lives in Ramona, California. He enjoys European travel, speaking French and Japanese, winemaking, and bungee-jumping.

John D. Meyer

Born in Timaru, New Zealand, John Meyer received a BS degree from the University of Canterbury in 1964 and a PhD degree from the University of Southern California in 1979. He joined HP Laboratories the same year and has since worked in the areas

of printing technologies, color reproduction, and computer simulation. Now a project manager in printing technologies, he has also investigated thermal ink-jet physics and analyzed novel printing technologies. He is named the inventor on two patent applications on ink-jet technologies. John lives in Mountain View, California with his wife. His outside interests include gardening, music, military history, and philosophy.

27 — Thin-Film Structure**Eldurkar V. Bhaskar**

Born in Madras, India, Eldurkar Bhaskar was awarded a bachelor's degree in electrical engineering from Mysore University in 1963. He also received a master's degree in high-voltage engineering from the Indian Institute of Science in 1965 and an MSEE

degree from Oregon State University in 1970. Before coming to HP in 1981, he worked in India on the development of semiconductor processes and on solar cell systems. In addition, he was an MOS designer for a U.S. semiconductor company. At HP, he has been responsible for thin-film development and for reliability testing. Bhaskar is married has two children, and lives in Corvallis, Oregon. His hobbies include woodworking and tennis.

J. Stephen Aden

Steve Aden was born in Oregon City, Oregon, and completed a BS degree in chemical engineering in 1981 at Oregon State University. He joined HP the same year and has specialized in thin-film process engineering, working on thermal printhead products as well as on the ThinkJet Printer. Steve currently lives in Corvallis, Oregon and is active in the Beyond War educational effort. He is a windsurfer, a pilot of hang gliders and other airplanes, and is "fascinated with wings of any kind."

33 — Orifice Plate**Paul H. McClelland**

Paul McClelland was born in Des Moines, Iowa but has lived in Oregon most of his life. He received a BS degree in chemistry from Portland State College in 1965 and an MS degree in chemistry from the University of Arizona in 1970. At HP since 1977, he supervised the Corvallis chemical mixing laboratory and the SEM laboratory and provided engineering support for chemical purchasing and disposal before joining the R&D team that was working on ink-jet technologies. He has published or presented papers on the analysis of heavy metals in water and the electrochemical properties of fluoride-doped tin oxides. He is also named as one of the coinventors on several patents on ink-jet technology. Paul, his wife and two children live in Pedee, Oregon where they operate a small cattle and sheep ranch. They enjoy travel and camping.

William R. Boucher

Bill Boucher received a BS degree in chemistry from San Jose State University in 1976 and worked for a manufacturer of magnetic discs before coming to HP in 1979. He has been a process engineer in printed circuit fabrication and an R&D engineer and production process engineer for the ThinkJet Printer. Bill was born in Tucson, Arizona and now lives in Corvallis, Oregon. He is a computer hobbyist and enjoys playing acoustic guitar.

Gary L. Siewell

Gary Siewell is a native of Coquille, Oregon and earned a BS degree in applied science in 1969 from Portland State University. After completing his education he first worked for a Northwest electronics firm and joined HP in 1972. His responsibilities at HP

have included work on cathode ray tube manufacturing, thermal printhead manufacturing, and ThinkJet Printer design. Gary lives in Albany, Oregon with his wife and ten children. Outside of work he enjoys photography, archery, and white water rafting.

38 — Managing New Technologies**Frank L. Cloutier**

Frank Cloutier was born in Los Angeles, California, received a BS degree in physics from Northeast Louisiana University in 1973, and came to HP the same year. He has managed work efforts for a number of areas, including a printhead, thin-film printing devices and magnetic read/write heads, and IC packaging. He is now R&D manager for thermal ink-jet technologies and devices for HP's InkJet Components Operation. Frank lives in Corvallis, Oregon, is married, and has two sons. He is an education director and a deacon in his church and enjoys computers, woodworking, and playing with his boys.

Hewlett-Packard Company, 3000 Hanover Street, Palo Alto, California 94304

HEWLETT-PACKARD JOURNAL

May 1985 Volume 36 • Number 5

Technical Information from the Laboratories of Hewlett-Packard Company

Hewlett-Packard Company, 3000 Hanover Street

Palo Alto, California 94304 U.S.A.

Hewlett-Packard Central Mailing Department

Van Heuven Goedhartlaan 121

1181 KK Amstelveen, The Netherlands

Yokogawa-Hewlett-Packard Ltd., Suginami-Ku Tokyo 168 Japan

Hewlett-Packard (Canada) Ltd.

6877 Goreway Drive, Mississauga, Ontario L4V 1M8 Canada

Bulk Rate
U.S. Postage
Paid
Hewlett-Packard
Company

CHANGE OF ADDRESS: To subscribe, change your address, or delete your name from our mailing list, send your request to Hewlett-Packard Journal, 3000 Hanover Street, Palo Alto, CA 94304 U.S.A. Include your old address label, if any. Allow 60 days.