

# Subregion- and Cell Type–Restricted Gene Knockout in Mouse Brain

Joe Z. Tsien,\* Dong Feng Chen,\*  
David Gerber,\* Cindy Tom,\* Eric H. Mercer,†  
David J. Anderson,† Mark Mayford,‡  
Eric R. Kandel,‡ and Susumu Tonegawa\*

\*Howard Hughes Medical Institute  
Center for Learning and Memory  
Center for Cancer Research  
Department of Biology  
Massachusetts Institute of Technology  
Cambridge, Massachusetts 02139

†Howard Hughes Medical Institute  
Division of Biology  
California Institute of Technology  
Pasadena, California 91125  
‡Howard Hughes Medical Institute  
Center for Neurobiology and Behavior  
Columbia University  
New York, New York 10032

## Summary

Using the phage P1–derived *Cre/loxP* recombination system, we have developed a method to create mice in which the deletion (knockout) of virtually any gene of interest is restricted to a subregion or a specific cell type in the brain such as the pyramidal cells of the hippocampal CA1 region. The *Cre/loxP* recombination–based gene deletion appears to require a certain level of Cre protein expression. The brain subregional restricted gene knockout should allow a more precise analysis of the impact of a gene mutation on animal behaviors.

## Introduction

Gene targeting in embryonic stem cells allows the production of mice containing a deletion in a predefined gene of interest, which is called gene knockout technology (Capecchi, 1989). This is a powerful technique for the functional identification of the gene product and has been widely used in biology and basic medicine (Capecchi, 1994). In the field of neuroscience, gene knockout technology has been particularly useful in uncovering molecular and cellular bases of behaviors (Silva et al., 1992a; Silva et al., 1992b; Grant et al., 1992). For instance, mice deficient in  $\alpha$ -calcium-calmodulin-dependent kinase II ( $\alpha$ CaMKII) displayed impairments both in the induction of long-term potentiation at hippocampal synapses (Silva et al., 1992a;) and in the acquisition of spatial memory (Silva et al., 1992b). These results supported the notion that synaptic strengthening underlies the formation of certain types of memory (Hebb, 1949; Eccles, 1953; Morris et al., 1986).

Conventional gene knockout techniques provide animals that inherit genetic deletions in all cell types. This regionally and temporally unrestricted genetic deletion

may lead to severe developmental defects or premature death (for a review, see Joyner, 1994), which can preclude analysis of postdevelopmental gene functions. If mutant mice do complete development, interpretation of the experimental results often runs into two types of difficulties. First, global gene knockout makes it difficult to attribute abnormal phenotypes to a particular type of cells or tissues. Second, it is often difficult to exclude the possibility that the abnormal phenotype observed in adult animals arises indirectly from a developmental defect.

To augment the utility of gene knockout technology, it is important to develop techniques that impose regional or temporal restrictions, or both, to genetic deletion. One method to accomplish cell type– or tissue type–restricted gene knockout is to exploit the *Cre/loxP* system, a phage P1–derived site–specific recombination system in which the Cre recombinase catalyzes recombination between 34 bp *loxP* recognition sequences (Sauer and Henderson, 1988). The *loxP* sequences can be inserted into the genome of embryonic stem cells by homologous recombination such that they flank one or more exons of a gene of interest (called a “floxed gene”). Of course it is crucial that the insertions do not interfere with normal expression of the gene. Mice homozygous for the floxed gene are generated from these embryonic stem cells by conventional techniques and are crossed to a second mouse that harbors a Cre transgene under the control of a tissue type– or cell type–specific transcriptional promoter. In progeny that are homozygous for the floxed gene and that carry the Cre transgene, the floxed gene will be deleted by *Cre/loxP* recombination but only in those cell type(s) in which the Cre gene–associated promoter is active (Figure 1A).

Previously, mice containing T cell–restricted gene knockout were generated based on the above principles (Gu et al., 1994). The goal of the present study was to create mice in which *Cre/loxP*–mediated recombination is restricted to specific regional or neuronal types. Several factors make this task particularly challenging. First, most neurons in the mammalian brain enter the postmitotic state relatively early during development and remain in that state throughout life, yet it is unclear whether *Cre/loxP* recombination can occur effectively in postmitotic cells. Second, mammalian neurons with similar cytoarchitecture (e.g., pyramidal cells) are often organized into similar structures in functionally distinct regions of the brain (e.g., CA1 versus CA3 regions of the hippocampus, or primary visual cortex versus somatosensory cortex). Thus, the question arises as to whether it is possible to knock out a gene differentially in these anatomically indistinguishable but functionally distinct regions of the brain.

In our initial attempt to develop brain subregion– or cell type–restricted gene knockout technology we used a promoter derived from the  $\alpha$ CaMKII gene to drive Cre gene expression. An earlier study demonstrated that the activity of this promoter in transgenic animals is restricted to the forebrain region (Mayford et al., 1995, 1996a, 1996b). We report here that efficient gene knockout can be accomplished in postmitotic neurons in a

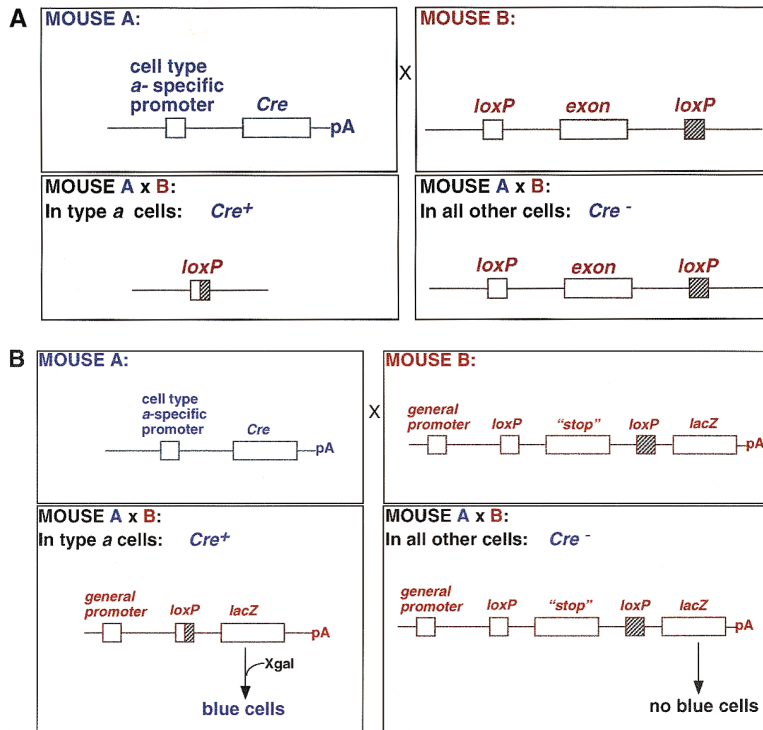

Figure 1. The *Cre/loxP* System for Gene Knockout

(A) Strategy for cell type-restricted gene knockout. (B) In situ detection of the *Cre* recombination by *lacZ* expression.

highly restricted manner within the forebrain, such as exclusively in CA1 pyramidal cells of the hippocampus.

**Results**

**Development of a Method for Forebrain-Restricted Gene Knockout**

Our strategy for the development of tissue- or cell type-restricted gene knockout in the brain was composed of two parts: first, production of *Cre* transgenic mouse lines in which *Cre* expression is restricted to certain regions or cell types within the brain, and second, assessment of the distribution and efficiency of *Cre/loxP* recombination within the brain using a functional assay (Figure 1B).

For the production of *Cre* transgenic mice, we chose the 8.5 kb genomic DNA fragment derived from the  $\alpha$ *CaMKII* gene, since an earlier study indicated that expression of  $\alpha$ *CaMKII* mRNA starts postnatally in the forebrain (Burgin et al., 1990). In addition, it has been shown that the 8.5 kb genomic DNA fragment can confer this regional specificity to a downstream coding sequence under transgenic conditions (Mayford et al., 1995, 1996a, 1996b). This regional specificity of the  $\alpha$ *CaMKII* promoter was attractive because of the possibility that it might permit a gene knockout restricted to the hippocampus and neocortical tissues known to play central roles in learning and memory. Furthermore, the lack of activity of the  $\alpha$ *CaMKII* promoter during prenatal and perinatal periods is expected to reduce the possibility of developmental defects caused by a gene knockout during early brain development.

The *Cre* DNA construct contains an intron and an SV40 polyadenylation signal at the 5' and 3' sides of

the *Cre* transgene, respectively, along with a nuclear localization signal (Kalderon et al., 1984) that may promote transport of *Cre* recombinase to the nucleus, the site of *Cre/loxP* recombination (Figure 2A).

To determine the distribution and efficiency of the *Cre/loxP* recombination, each *Cre* transgenic mouse line was crossed to a *reporter* mouse (Figure 1B). *reporter* mice were generated by incorporating a transgene in which the chicken  $\beta$ -actin promoter drives the expression of a *lacZ* gene, whose transcription and translation are prevented by a "stop" sequence (Lasko et al., 1992) flanked by *loxP* sites. This transgene is called *cAct-XstopXlacZ* (Figure 2B). *Cre*-mediated recombination

A. Construct (pJT-CRE) for production of *Cre* Mouse

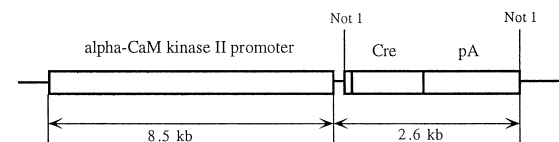

B. Construct (pcAct-XstopX-LacZ) for production of *Reporter* Mouse

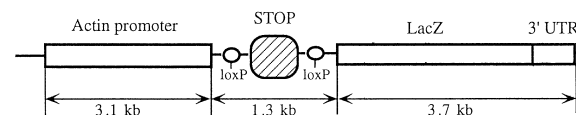

Figure 2. Plasmid Constructs

(A) Schematic representation of a construct *pJT-Cre* for production of *Cre* transgenic mouse. (B) Schematic representation of a construct *pcAct-XstopXlacZ* for production of *reporter* mouse.

removes the stop sequence, allowing expression of  $\beta$ -galactosidase in all cell types in which the chicken  $\beta$ -actin promoter is active (Figure 1B, left). In control experiments, transgenic mice expressing a chicken  $\beta$ -actin promoter-*lacZ* transgene exhibited  $\beta$ -galactosidase expression in postmitotic neurons of the brain, spinal cord, and peripheral nervous system, as well as in the heart and some skeletal muscle (E. H. M. and D. J. A., unpublished data). A similar pattern of  $\beta$ -galactosidase expression was observed when *reporter* mice containing the *cAct-XstopXlacZ* transgene were crossed to activator mice expressing Cre under the control of the cytomegalovirus promoter-enhancer (Zinyk et al., unpublished data).

In double-transgenic mice that carry the  $\alpha$ CaMKII-Cre transgene and the *cAct-XstopXlacZ* transgene, forebrain cells should express Cre recombinase at sufficiently high levels to allow *Cre/loxP* recombination, resulting in the deletion of the stop sequence and expression of the *lacZ* gene (Figure 1B). In the remaining regions of the brain and in other tissues, expression of the Cre transgene should be absent or very low, so that no *Cre/loxP* recombination and no expression of the transgenic *lacZ* gene occur. Although the activity of the transgenic  $\alpha$ CaMKII promoter is restricted to the forebrain, the exact distribution and strength of its activity within the forebrain can vary from one transgenic line to another. We therefore assessed the distribution and efficiency of *Cre/loxP* recombination in each Cre transgenic line by crossing it with the *reporter* mouse and analyzing X-Gal-stained brain sections from *Cre/lacZ* double-transgenic mice.

#### Generation and Characteristics of Cre Transgenic Mice

We produced a total of 14 independent Cre transgenic founder mice by pronuclear injection of the linearized Cre DNA construct. Southern blot analysis of the DNA isolated from the offspring of the 14 founders indicated that 11 had transmitted 1–20 copies of the Cre transgene through the germline. One founder, T29, apparently had two clusters of the transgene on separate chromosomes since these clusters segregated during early breeding to generate two sublines, T29–1 and T29–2, each exhibiting distinct distributions of *Cre/loxP* recombination (see below).

The expected forebrain-restricted expression of the Cre transgene was tested in 9 of the 11 founder lines by Northern blot analysis of RNA derived from two broad subregions of the brain: the cortex and hippocampus combined (forebrain) and the cerebellum and brain stem combined (hindbrain) (Figure 3A). Four lines, T17, T29, T40, and T50, (T50 data not shown) expressed the expected 2.6 kb Cre mRNA in forebrain but not in hindbrain. The fifth line, T44, expressed an abnormally large (9 kb) Cre sequence-containing mRNA in both forebrain and hindbrain. This mRNA may have originated from a fusion gene composed of a broadly active endogenous gene and the integrated Cre transgene. The remaining four founder lines, T28, T35, T46, and T58 (data for T28 and T46 not shown), expressed no detectable Cre mRNA. A subsequent experiment indicated that both

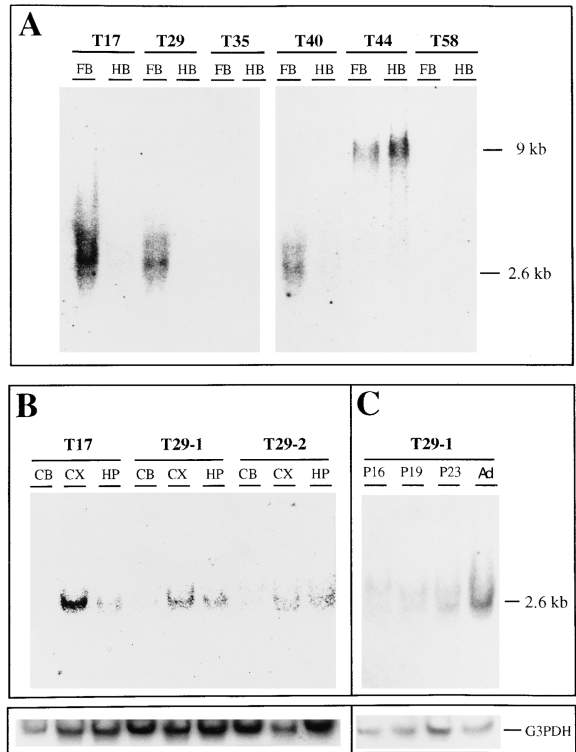

Figure 3. Northern Blot Analysis of Cre mRNA Expression in the Adult Brain from Transgenic Lines

(A) Cre mRNA expression in adult forebrain (FB) regions (cortex and hippocampus) and hindbrain (HB) regions (cerebellum and brain stem) from mouse lines T17, T29, T35, T40, T44, and T58. Twenty micrograms of total RNA per lane was loaded and blotted. The size of Cre mRNA is indicated at right.

(B) Cre mRNA expression in adult cortex (CX), hippocampus (HP), and cerebellum (CB) from brains of mouse lines T17, T29–1, and T29–2. The expected 2.6 kb Cre mRNA is indicated.

(C) Expression of Cre mRNA in the developing hippocampus of T29–1 at P16, P19, P23, and adult (Ad). In (B) and (C) 10  $\mu$ g/lane total RNA was loaded and blotted as described in Experimental Procedures. The same blot was reprobed with G3PDH probe as a control for the amount of RNA loaded. G3PDH, glycerol-3-phosphate dehydrogenase.

T29–1 and T29–2 sublines also expressed the normal 2.6 kb Cre mRNA only in forebrain (data not shown). We dissected out the cortex and hippocampus separately from T17, T29–1, and T29–2 and examined each, along with the cerebellum, for Cre mRNA expression. Both cortex and hippocampus of all three lines contained the 2.6 kb Cre mRNA, while it was negative or barely detectable in cerebellum (Figure 3B). In T29–1 and T29–2, the amount of the Cre mRNA was similar in cortex and hippocampus, but in T17 it seemed to be greater in cortex than in hippocampus.

Although the transcription of mRNA of *CaMKII* driven by the  $\alpha$ CaMKII promoter has been shown to be silent until several days after birth (Burgin et al., 1990), when most neural circuits are already formed (Pokorny and Yamamoto, 1981a, 1981b; Stanfield and Cowan, 1979), it was still possible that the Cre transgene could somehow disrupt normal development of the brain. We therefore examined the gross brain anatomy of the brains of several Cre transgenic lines by Nissl staining. We found no

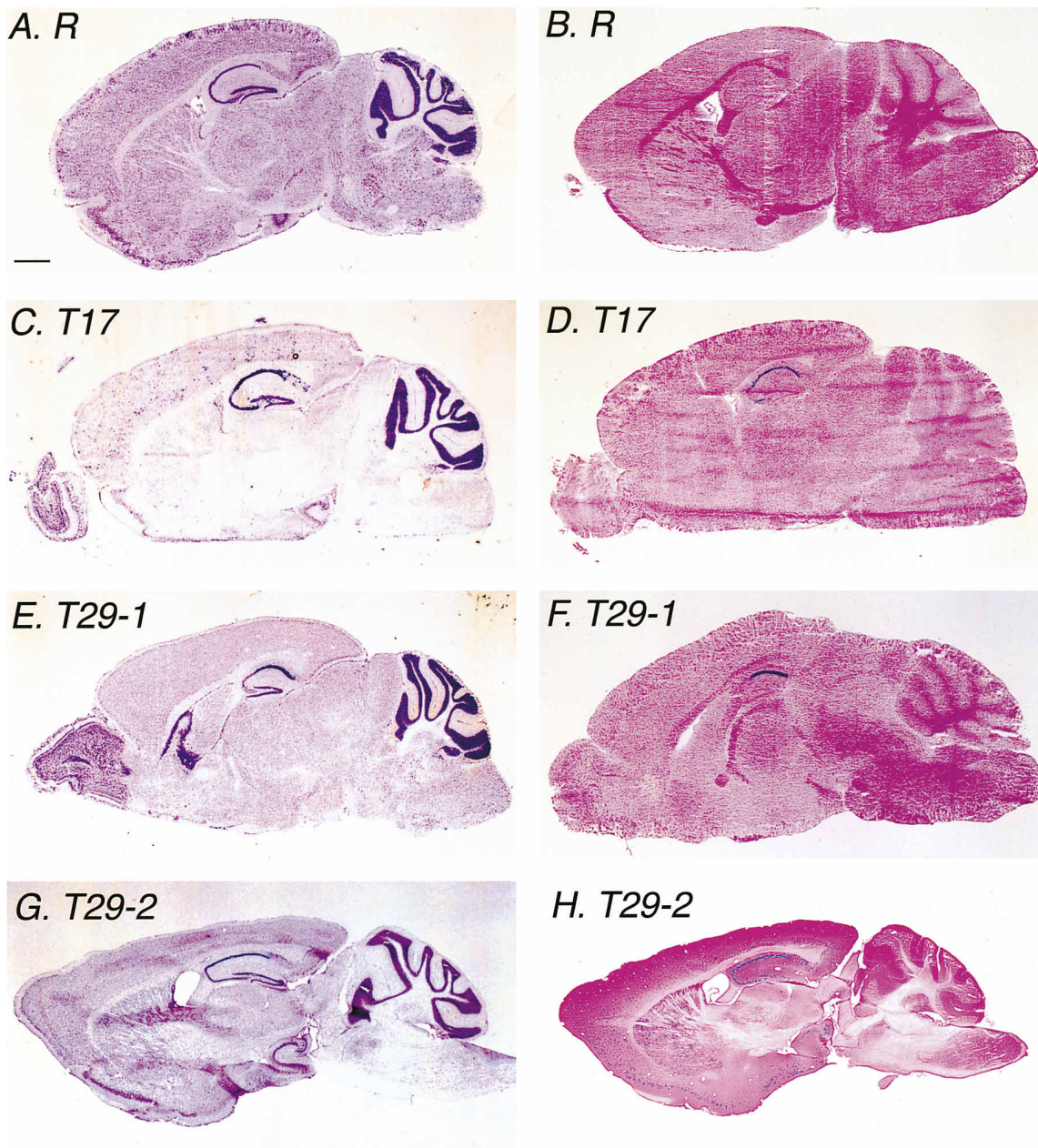

Figure 4. *Cre/loxP* Recombination Patterns in the Brains from Different *Cre/lacZ* Transgenic Lines Determined by X-Gal Blue Staining  
Sagittal brain sections of the *lacZ reporter* (R), T17//*lacZ*, T29-1//*lacZ*, and T29-2//*lacZ* mice were stained with X-Gal and then counterstained with cresyl violet (A, C, E, G) or with eosin (B, D, F, H). In cresyl violet-stained sections, cerebellum and hippocampal neurons are heavily stained, partially obscuring the X-Gal staining, which is restricted to different regions of the forebrain in all lines illustrated (see eosin-stained sections). Scale bar, 1 mm.

significant difference in the organization of the various brain nuclei or in the arrangement of cell layers within major brain nuclei in several *Cre* transgenic lines compared to nontransgenic littermates (Figures 4 and 5). We also observed no overt behavioral abnormalities in the *Cre* transgenic mice.

***Cre/loxP*-Mediated Recombination in the Forebrain**  
We crossed five *Cre* transgenic lines or sublines (T17, T29-1, T29-2, T40, and T50) with the *lacZ* transgenic

*reporter* mouse and analyzed sagittal brain sections of the double- transgenic mice by X-Gal staining (Figures 4 and 5 and data not shown). We observed that *Cre/loxP* recombination, as depicted by blue cells, was remarkably restricted to the forebrain. In T17//*lacZ* double-transgenic mice, dense staining was observed in the CA1 region of the hippocampus and somewhat lighter staining in the CA3 region (Figures 4C, 4D, and 5C). Judging from the size of the cells and their location within the hippocampus, most of the stained cells appeared to be pyramidal cells (Figures 5C and 5D). Only



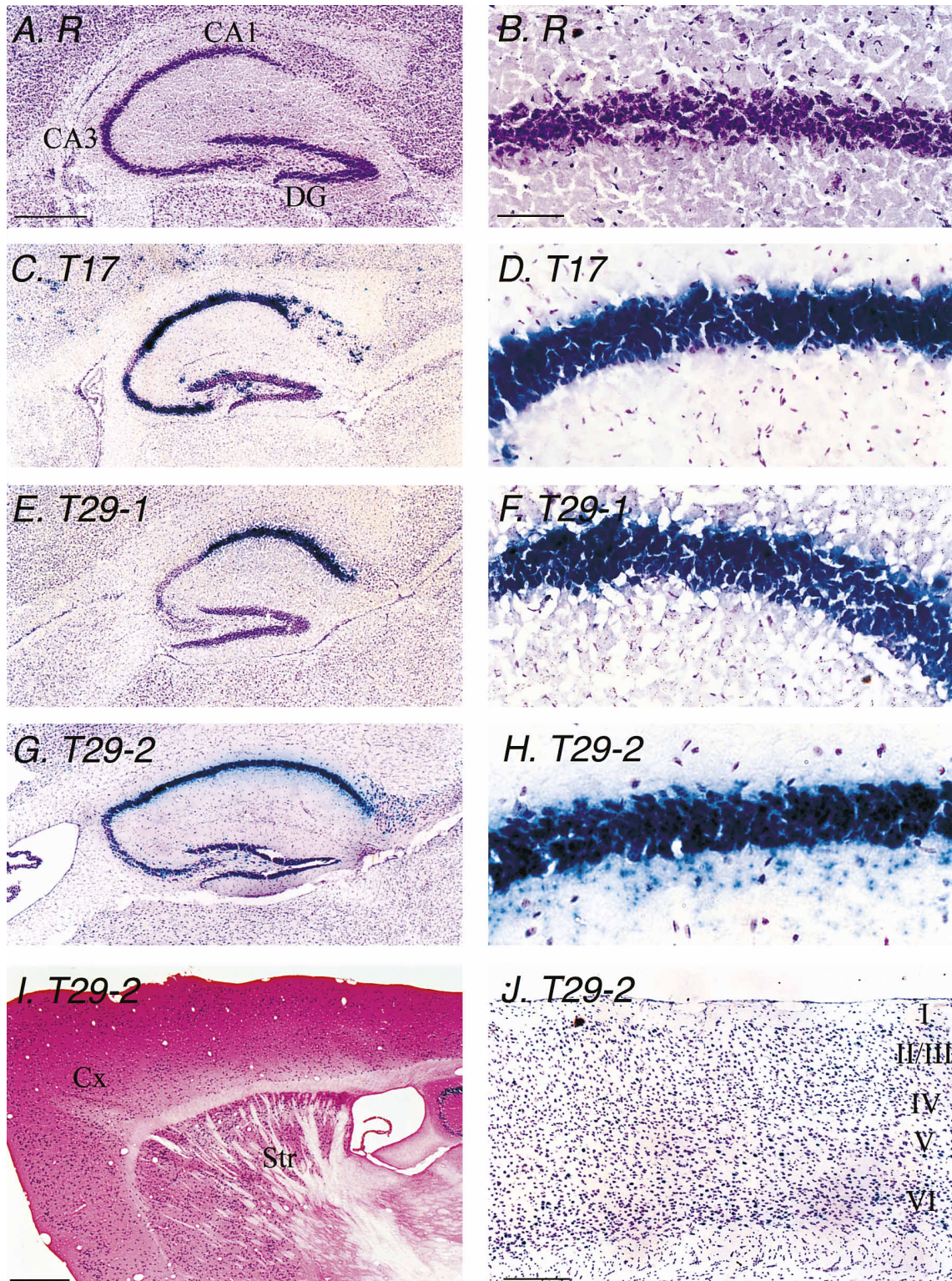

Figure 5. Distribution and Efficiency of *Cre/loxP* Recombination in Various Transgenic Mice Examined at Higher Magnification  
(A, C, E, and G) The distribution of *Cre/loxP* recombination in the hippocampus of the *reporter* T17/*lacZ*, T29-1/*lacZ*, and T29-2/*lacZ* mice, respectively, as visualized by X-Gal staining and cresyl violet counterstaining. Scale bar, 500  $\mu$ m.  
(B, D, F, and H) The CA1 region of the hippocampus from the same set of mice. Scale bar, 100  $\mu$ m. (I) The cortex and striatum of T29-1/*lacZ*. Scale bar, 500  $\mu$ m. (J) The cortex of T29-2/*lacZ*. Scale bar, 200  $\mu$ m.

Table 1. Efficiency of Cre/loxP Recombination Assessed by Quantification of X-Gal–Stained Cells

Mouse Line	CA1	CA3	Dentate Gyrus	Cortex	Striatum	Cerebellum
T17// <i>lacZ</i>	76% (348/457)	62% (99/159)	8.6% (83/962)	16% (97/609)	4.4% (28/628)	0%
T29-1// <i>lacZ</i>	98% (1126/1150)	1.4% (5/368)	0.3% (10/2981)	0.2% (17/7500)	0.5% (14/3000)	0%
T29-2// <i>lacZ</i>	99.5% (428/430)	43% (69/138)	14% (129/908)	9.4% (94/1000)	29% (243/1000)	0%
T40// <i>lacZ</i>	99% (405/409)	0% (0/128)	0.1% (1/1000)	0% (0/1000)	0% (0/1250)	0%
T50// <i>lacZ</i>	96% (1167/1215)	0.7% (3/430)	0.3% (8/3028)	0.3% (21/7500)	0.2% (7/2900)	0%

The numbers in parentheses indicate X-Gal–stained cells/total cells. The percentages of X-Gal–positive cells were calculated from these numbers.

occasional cells were stained in the dentate gyrus and in the cortex (Figure 5C). No stained cells were detected in the remaining brain regions such as cerebellum, brain stem, and thalamus (Figures 4C and 4D).

In T29-1//*lacZ* double-transgenic mice the staining was highly restricted to the CA1 pyramidal cell layer of the hippocampus (Figures 4E, 4F, 5E, and 5F). The frequency of stained cells within the pyramidal cell layer was high: virtually all cells were stained (Figures 5E and 5F). This staining pattern was maintained throughout the longitudinal axis of the hippocampus (data not shown). Remarkably, two other independently derived *Cre* transgenic lines, T40 and T50, gave staining patterns that were indistinguishable from that of T29-1 (data not shown).

The broadest distribution of staining was observed in

T29-2//*lacZ* double-transgenic mice (Figures 4G, 4H, 5G, and 5H). In these mice, blue cells were observed in CA1 and CA3 pyramidal cell layers and in the dentate granular cell layer of the hippocampus as well as in the cortex (Figure 5J) and striatum (Figure 5I).

We assessed the proportion of cells that had undergone the *Cre/loxP* recombination in each subregion of the brain by counting the numbers of X-Gal–stained cells and Nissl- stained cells in brain sections that had been treated with both dyes (Table 1). The data generally confirm the impressions obtained by casual inspection of the stained sections represented in Figures 4 and 5.

We also examined possible intraline variability of T29-1 and T50 and found no significant differences in the X-Gal staining patterns among multiple individuals belonging to the same line.

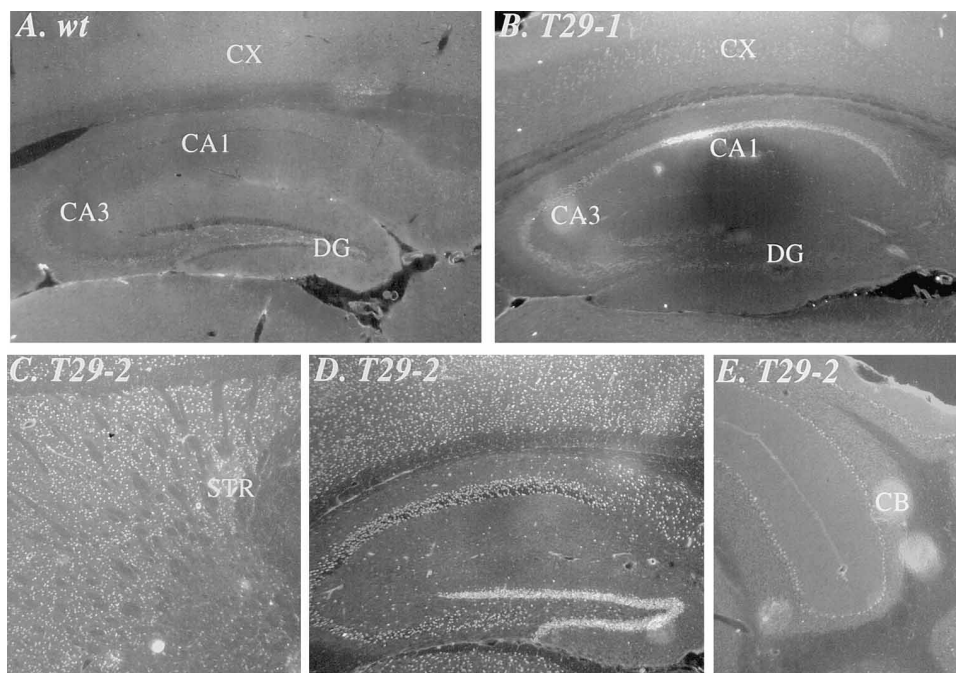

Figure 6. Immunohistochemistry of Cre Protein in the Brains from wild-type, T29-1, and T29-2 Mice

(A) Hippocampus and cortex (CX) of the wild-type mice, stained with the Cre monoclonal antibody. (B) Hippocampus and cortex of T29-1. DG, Dentate gyrus. (C) Striatum (STR) region of T29-2. (D) Hippocampus and cortex of T29-2. (E) Cerebellar (CB) region of T29-2.



### Cre Recombinase Distribution Roughly Correlates with the Distribution of Cre/loxP Recombination

Within the forebrain the distribution of Cre mRNA, as roughly assessed by Northern blot analysis, did not seem to correlate well with the distribution of Cre/loxP recombination. For instance, in T29-1 mice, Cre mRNA appears to be as abundant in the cortex as in the hippocampus (Figure 3B), whereas Cre/loxP recombination was highly restricted to the CA1 pyramidal cell layer of the hippocampus in T29-1/lacZ double-transgenic mice (Figures 4E, 4F, 5E, and 5F).

To identify parameters that affect the distribution of Cre/loxP recombination, we examined the distribution of the Cre recombinase in T29-1 and T29-2 brains by immunohistology using an anti-Cre monoclonal antibody (see Experimental Procedures) (Figure 6). In T29-1, staining with the antibody was significantly greater in the CA1 pyramidal cell layers than in other regions of the forebrain, including CA3 and the dentate gyrus of the hippocampus and neocortex (Figure 6B). In contrast, in T29-2, the Cre epitope was more widely spread within the hippocampus (Figure 6D) and was clearly visible in the cortex (Figure 6D) and in the striatum (Figure 6C). In addition, the cerebellar Purkinje cells seem to be stained, albeit lightly (Figure 6E). No staining was observed in the control wild-type mouse sample (Figure 6A).

These results indicate that the frequency of Cre recombinase-positive cells correlates fairly well with the frequency of Cre/loxP recombination-positive cells in various parts of the brain, although a few exceptions (e.g., T29-2 cerebellum) were noticed.

### Cre/loxP Recombination Occurs during the Third Postnatal Week

We examined the developmental time course of Cre/loxP recombination in several Cre/lacZ double-transgenic mice by subjecting brain sections from mice of varying ages to X-Gal staining. In T17/lacZ, T29-1/lacZ, and T29-2/lacZ mice, no X-Gal staining was observed at P16 or earlier (Figures 7A, 7D, 7H, and 7I). In T17/lacZ mice, stained cells were first detected in the outer pyramidal cell layer of the CA1 region at P18 (Figure 7B). At this stage the majority of CA1 pyramidal cells clearly were unstained. However, the staining spread to the majority of CA1 pyramidal cells and to some CA3 cells by P23, when the adult pattern of staining was almost established. In T29-1/lacZ mice, we first observed the Cre recombination at P19 (Figure 7E). As the mice aged, the recombination spread to more cells but was strictly restricted to the CA1 pyramidal cell layer (Figures 7F and 7G). By P29, the adult pattern of recombination was established (Figure 7G). In agreement with this developmental course of Cre/loxP recombination, the level of Cre mRNA in the hippocampus of T29-1 mice was low at P16 and P19, but substantial at P23 (Figure 3C). In T29-2/lacZ mice, the Cre/loxP recombination was detectable at P19 in a minority of cells in hippocampal regions, in the cortex, and in the striatum (Figures 7J and 7K).

Thus, in the Cre/lacZ double-transgenic mouse lines examined, Cre/loxP recombination was initiated during

the middle of the third postnatal week, with the adult pattern of recombination established by the fourth postnatal week.

### Discussion

Our data indicate that the Cre/loxP recombination system can be used to generate mouse strains in which deletion in a predefined gene can be regionally and temporally restricted in the brain. The major factor that determines this specificity is the nature of the transcriptional promoter that drives the expression of the Cre gene. In this study we used the transgenic  $\alpha$ CaMKII promoter shown to be specific for cells in the forebrain (Mayford et al., 1995, 1996a, 1996b) and presumably active only postnatally (Burgin et al., 1990). Consistent with these characteristics of the  $\alpha$ CaMKII promoter, we found that Cre/loxP recombination is restricted to cells in the forebrain and occurs during the third postnatal week. The fact that Cre/loxP recombination does not occur until the third postnatal week is advantageous. By knocking out a gene of interest at the third postnatal week, one can avoid most if not all of the developmental effects of the gene deletion, thus allowing more precise interpretation of the gene function in adulthood.

Different Cre transgenic lines gave rise to different patterns of the Cre/loxP recombination within the forebrain. Such variations are not surprising since each transgenic line represents a unique genomic site of integration and each locus can modify the promoter specificity and Cre expression. However, we are somewhat surprised at the stringency with which Cre/loxP recombination is confined to CA1 pyramidal cells in several Cre/lacZ transgenic lines (T29-1, T40, and T50 with the lacZ transgene) and at the high frequency (three of five) with which these Cre transgenic lines were found. Although unknown technical reasons prevented us from determining the precise distribution of Cre mRNA by in situ hybridization, the Northern blot data suggest that the overall content of Cre mRNA in the cortex is not substantially lower than that in the hippocampus in T29-1 mice. Nevertheless, immunohistology with anti-Cre monoclonal antibody indicated that the recombinase is more abundant in the CA1 pyramidal cell layer than in the rest of the hippocampus and in the cortex. One possibility is that the  $\alpha$ CaMKII promoter is particularly active in CA1 pyramidal cells, such that the minimal level of Cre recombinase required for the recombination is reached more frequently in these cells as opposed to other forebrain cells. Another possibility is that CA1 pyramidal cells provide environmental factors that are favorable for the synthesis, stability, transport, or activity of the Cre recombinase.

In our study, brain subregional and cell type specificity of Cre/loxP recombination was determined using the floxed stop and lacZ sequences integrated at a particular genomic locus as the recombination substrate. Does the integration site of the recombination substrate (i.e., loxP site) affect the regional or cell type specificity of Cre/loxP recombination? We examined this issue by crossing T29-1 mice with mice carrying the floxed genomic NMDAR1 gene. As shown in an accompanying article, NMDAR1 gene knockout appears to be restricted

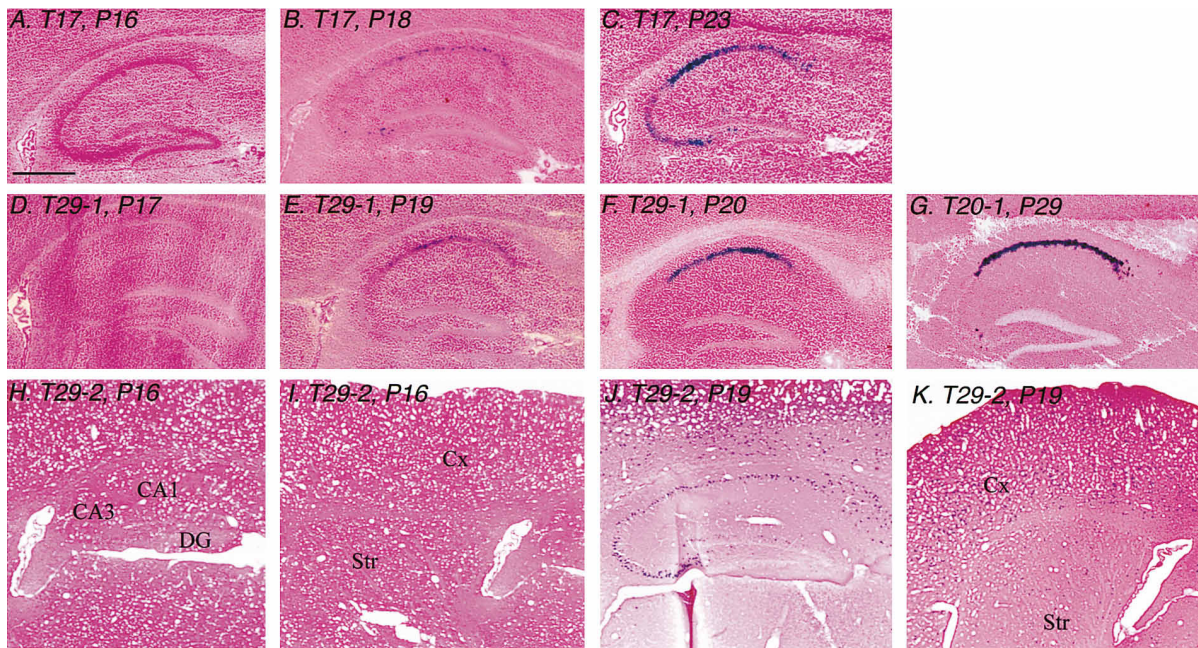

Figure 7. Developmental Time Course of *Cre/loxP* Recombination in Three *Cre* Transgenic Mice Individually Crossed to the *lacZ* reporter Mice  
The brain sections were stained with X-Gal and counterstained with eosin. The types and postnatal dates of the mice are indicated. (A–H and J) The hippocampus. (I and K) The cortex and striatum. DG, dentate gyrus; CX, cortex; Str, striatum. Scale bar, 500  $\mu$ m.

to CA1 pyramidal cells in progeny carrying the transgenic *Cre* gene and floxed genomic *NMDAR1* gene (Tsien et al., 1996 [this issue of *Cell*]). Consequently, the pattern of the *Cre/loxP* recombination does not seem to be affected substantially by the integration site of the substrate. Thus, the transgenic *lacZ* mouse appears to be a good reporter of *Cre/loxP* recombination, although the exact distribution of the gene knockout will need to be confirmed using the mouse carrying the specific floxed gene of interest.

CA1 pyramidal cells undergo neurogenesis between E10 and E18 (Angevine, 1965) and enter the postmitotic state by P0. They are well differentiated by P7, with fully established synaptic connections (Pokorny and Yamamoto, 1981a, 1981b; Stanfield and Cowan, 1979). We have found that *Cre/loxP* recombination occurs during the middle or end of the third postnatal week in the CA1 pyramidal cells in several *Cre/lacZ* mice, indicating that this type of recombination is not inhibited by the highly differentiated, postmitotic state of the CA1 neurons. If other types of neurons can also accommodate postmitotic recombination, the development of a *Cre/loxP*-based inducible gene knockout technology should greatly benefit neuroscientific studies (see below). This technology will be advantageous because most approaches will require the induction of a gene knockout in an adult animal containing neurons that are in advanced postmitotic states.

In the work described here the  $\alpha$ *CaMKII* promoter was used to drive expression of the *Cre* transgene, but there is no reason why other transcriptional promoters would not be effective. In fact, we have recently used the *L7* promoter, which has been reported to be active preferentially in the Purkinje cells of the cerebellum under

certain transgenic conditions (Oberdick et al., 1990). We have been able to produce *L7* promoter/*Cre* transgenic mouse lines that restrict *Cre/loxP* recombination to Purkinje cells (M. Hasan and S. T., unpublished data). A broader application of this technology for neuroscience depends on the availability of transcriptional promoters that are specific for a certain region or cell type in the brain. Several genes that exhibit regionally restricted expression within the brain have been reported (Oberdick et al., 1990; Wei, et al., 1991), and their associated promoters should provide useful reagents. While it is certain that the expression of some genes is controlled at the transcriptional level in brain cells and that some genes are active only in certain tissues or cell types, it is not clear how numerous these genes are and how restricted their expression patterns are. For instance, it would be useful to identify genes and their promoters that are active only in a certain region of the cortex that shares similar anatomical features with other cortical regions but that differs in function. In this respect, our finding that *Cre/loxP* recombination occurs efficiently in CA1 pyramidal cells but remains undetectable in CA3 pyramidal cells in transgenic lines is encouraging. Systematic attempts to identify and clone differentially active genes in the central nervous system could provide further reagents.

Studies of molecular and cellular mechanisms underlying behavioral characteristics of a vertebrate animal have traditionally been carried out using pharmacological blockades (Morris et al., 1986; Davis and Squire, 1984), namely by introducing a receptor antagonist or an enzyme inhibitor into the brain and determining the effect on a specific behavior. The tissue- or cell type-restricted gene knockouts provide an alternative means.



While the two methods are complementary, genetic deletion is generally superior to pharmacological blockade with respect to molecular and anatomical specificities and animal-to-animal reproducibility (Davis et al., 1992; Saucier et al., 1996). For instance, while many antagonists cannot distinguish receptor isoforms, genetic blockade can make that distinction. Likewise, while it is difficult to target a drug with the same concentration reproducibly to a specific area of the brain, or especially to a specific cell type, a genetic blockade can be highly confined and reproducible, as evidenced by the T29-1 line.

One limitation of the genetic technology available now is the lack of a temporal control. However, temporal restrictions can be added to the cell type-restricted knockout technology by combining it with, for instance, the recently reported gene induction system based on the tetracycline repressor/operator system or other inducible system (Kistner et al., 1996; Zhang et al., 1996; Wang et al., 1994).

#### Experimental Procedures

##### Transgene Construction

The *Cre* transgene expression vector pJT-CRE was constructed by inserting the 2.6 kb NotI fragment of plasmid pZQCRE into the unique NotI site of pMM279 containing a 8.5 kb *CaMKII* promoter sequence (Mayford et al., 1995, 1996a, 1996b). The 2.6 kb NotI fragment of pZQCRE was composed of the *Cre* transgene with a nuclear localization signal (Kalderon et al., 1984) (pBS317, gift from Brian Sauer) and an exon-intron splicing and polyadenylation signals (pNN265, a gift from Nobuki Nakanishi). The *Cre* transgene in expression vector pJT-CRE was verified by DNA sequencing.

##### Transgenic Mouse Production

The 11.2 kb linearized DNA containing the  $\alpha$ *CaMKII* promoter and the *Cre* transgene was obtained by digestion of pJT-CRE with SalI and purified away from plasmid sequence. The transgenic founders were produced by pronuclear injection of the linearized DNA into BCF1 zygotes as described (Hogan et al., 1986). The *Cre* founders were back-crossed into the B6 background for production of transgenic offspring. The *Cre* transgenic mice from lines T17, T29-1, T29-2, T40, and T50 were also crossed with the *Cre* recombination-reporter mice that carry a transgene containing a chicken  $\beta$ -actin promoter-loxP-stop sequence-loxP-lacZ gene. The lacZ gene bears a nuclear localization signal at its 5' end (Zinyk et al., unpublished data).

##### Genotyping of Transgenic Mice

The genotypes of all offspring were analyzed by Southern blot or polymerase chain reaction. For analysis by polymerase chain reaction, mouse tail DNAs (about 1  $\mu$ g) were amplified 30 cycles (1 min, 94°C; 45 seconds, 55°C; and 1 min, 72°C) on a thermal cycler. The 5' and 3' primers for the *Cre* transgene (490 bp amplified) were 5'-AGATGTTTCGCGATTATC-3' and 5'-AGCTACACCAGAGACGG-3', respectively. The 5' and 3' primers for the *lacZ* gene (825 bp amplified) were 5'-GACACACAGACCAACTGGTAATGG-3' and 5'-GCATCG AGCTGGGTAATAAGCG-3', respectively. For Southern blot analysis, tail DNA were digested with BamHI or XbaI and processed according to Sambrook et al. (1989). A 0.8 kb BamHI fragment of pBS317 was used as a hybridization probe. Hybridization was at 65°C overnight in a solution containing 10% dextran sulfate, 6 $\times$  SSC, 1% SDS, and 100  $\mu$ g/ml denatured salmon sperm DNA. Filters were washed twice for 5 min each in 2 $\times$  SSC at room temperature and twice for 30 min each in 0.1 $\times$  SSC at 65°C before exposure to films or Intensifying Plate screens (Fuji).

##### Northern Blot Analysis

Mice were killed by cervical dislocation, and various regions of the mouse brain were quickly dissected in ice-cold PBS buffer and

frozen immediately in liquid nitrogen. Total RNA was purified using the guanidium thiocyanate method or Tri-reagent method. Ten micrograms of total mRNA was electrophoresed through agarose-formaldehyde gels, transferred onto nitrocellulose with 10 $\times$  SSC (Schleicher and Schuell). The filters were hybridized to <sup>32</sup>P-labeled *Cre* probe or G3PDH probe (Clontech) in a quick hybridization solution (Stratagene) according to the provided manuals and washed under high stringency conditions (twice for 5 min each in 2 $\times$  SSC at room temperature and three times for 15 min each in 0.1 $\times$  SSC at 65°C). The filters were exposed to films or Intensifying Plate screens (Fuji).

##### Histology

The brains from transgenic and wild-type mice at various age were perfused with ice-cold PBS buffer and 30% sucrose, dissected, and rapidly frozen in mounting medium. Cryostat sections (15–20  $\mu$ m) were prepared and postfixed for 5 min in 4% paraformaldehyde in PBS buffer (pH 7.5). The fixed sections were washed twice with PBS and subjected to X-Gal staining overnight for up to 20 hr at room temperature. The X-Gal staining solution contains 1 mg/ml X-Gal (4-chloro-5-bromo-3-indolyl- $\beta$ -galactosidase), 4 mM K<sub>4</sub>Fe(CN)<sub>6</sub>·3H<sub>2</sub>O, 4 mM K<sub>3</sub>Fe(CN)<sub>6</sub>, and 2 mM MgCl<sub>2</sub> in PBS. The X-Gal-stained slides were washed with PBS twice and once in distilled water and then counterstained with eosin or cresyl violet (Nissl staining). Light microscopy was performed at 1.25–20 $\times$  magnification on a Nikon microscope.

##### Estimation of *Cre/loxP* Recombination Efficiency

Brain sections (20  $\mu$ m) that were double-stained by X-Gal and cresyl violet were examined under a Nikon microscope, and the number of neurons was counted. In the hippocampus, all of the neurons in CA1, CA3, and dentate gyrus from the slides were counted. In the cortical area, all the neurons in five adjacent fields (each field is 400  $\mu$ m  $\times$  400  $\mu$ m) that, as a whole, covered the entire six lamina layers were counted. In the striatum, the neurons in five randomly selected fields (each field is 400  $\mu$ m  $\times$  400  $\mu$ m) were counted. In the cerebellum, we screened the whole area from each slide, and no X-Gal-stained cells were found. The percentage of X-Gal-positive neurons of the total number of neurons from each brain subregion was calculated. The data were obtained with a single brain section from each strain of mouse except for T29-1/lacZ and T50/lacZ, whose data come from three brain sections, one section per animal.

##### Immunohistochemistry

For immunohistochemical analysis of the *Cre* transgenic and wild-type mice, the brains were perfused with cold PBS and then with 4% paraformaldehyde. The brains were dissected out and submerged in 30% sucrose at 4°C for 2 days before cryostat sectioning (20  $\mu$ m). The *Cre* antibody (catalog number MMS106P, Berkeley Antibody) was applied to slides at a dilution of 1:100 and incubated at room temperature over night or for a week at 4°C before application of the secondary antibody (fluorescein isothiocyanate, Vector) according to the instructions of the manufacturer. Fluorescence microscopy was performed at 10 $\times$  magnification with a Nikon microscope, and the images were collected with a computerized camera.

##### Acknowledgments

We wish to thank Jason Derwin for technical help and Emily Rossie and Pamela Woronoff for secretarial help. We are grateful to Brian Sauer for the gift of plasmid pBS317 and to Nobuki Nakanishi for the gift of plasmid pNN265. This work was supported by National Institutes of Health grant NS32925 and by gifts from the Shionogi Institute for Medical Science and Amgen, Inc. (all to S.T.).

Received November 8, 1996; revised November 25, 1996.

##### References

- Angevine, J.B. (1965). Time of neuron origin in the hippocampal region. *Exp. Neurol. Suppl.* 2, 1–70.
- Burgin, K.E., Waxham, M.N., Rickling, S., Westgate, S.A., Mobley, W.C., and Kelly, P.T. (1990). *In situ* hybridization histochemistry of

- Ca<sup>2+</sup>/calmodulin-dependent protein kinase in developing rat brain. *J. Neurosci.* **10**, 1788–1798.
- Capecchi, M.R. (1989). Altering the genome by homologous recombination. *Science* **244**, 1288–1292.
- Capecchi, M.R. (1994). Targeted gene replacement. *Sci. Am.* **270**, 52–59.
- Davis, H.P., and Squire, L.R. (1984). Protein synthesis and memory. *Psychol. Bull.* **96**, 518–559.
- Davis, S., Butcher, S.P., and Morris, R.G.M. (1992). The NMDA receptor antagonist D-2-amino-5-phosphopentanoate (D-AP5) impairs spatial learning and LTP in vivo at intracerebral concentrations comparable to those that block LTP in vitro. *J. Neurosci.* **12**, 21–34.
- Eccles, J.C. (1953). The neurophysiological basis of mind. In: *The Principles of Neurophysiology* (Oxford: Clarendon Press).
- Grant, S.U.N., O'Dell, T., Karl, K.A., Stein, P., Soriano, P., and Kandel, E.L. (1992). Impaired long-term potentiation, spatial learning, and hippocampal development of *fyn* mutant mice. *Science* **258**, 1903–1910.
- Gu, M., Marth, J.D., Orban, P.C., Mossmann, H., and Ragewsky, K. (1994). Deletion of a DNA polymerase  $\beta$  gene segment in T cells using cell type-specific gene targeting. *Science*, **265**, 103–106.
- Hebb, D.O. (1949). *The organization of behavior*. New York: Wiley.
- Hogan, B., Constantin, F., and Lacy, E. (1986). *Manipulating the mouse embryo: a laboratory manual* (Plainview, New York: Cold Spring Harbor Press).
- Joyner, A.L. (1994). Gene targeting and development of the nervous system. *Curr. Opin. Neurobiol.* **4**, 37–42.
- Kalderon, D., Roberts, B.L., Richardson, W.D., and Smith, A.E. (1984). A short amino acid sequence able to specify nuclear location. *Cell* **39**, 449–509.
- Kistner A., Gossen, M., Zimmerman, F., Jerecic, J., Ullmer, E., Lubbert, H., and Bujard, H. (1996). Doxycycline-mediated quantitative and tissue-specific control of gene expression in transgenic mice. *Proc. Nat. Acad. Sci. USA* **93**, 10933–10938.
- Lasko, M., Sauer, B., Mosinger, B., Lee, E.J., Manning, R.W., Yu, S.-H., Mulder, K.L., and Westphal, H. (1992). Targeted oncogene activation by site-specific recombination in transgenic mice. *Proc. Natl. Acad. Sci. USA* **89**, 6232–6236.
- Mayford, M., Wang, J., Kandel, E.L., and O'Dell, T. (1995). CaMKII regulates the frequency-response function of hippocampal synapses for the production of both LTD and LTP. *Cell* **81**, 891–904.
- Mayford, M., Baranes, D., Podsypanina, K., and Kandel, E. (1996a). The 3'-untranslated region of CaMKII  $\alpha$  is a cis-acting signal for the localization and translation of mRNA in dendrites. *Proc. Natl. Acad. Sci. USA*, in press.
- Mayford, M., Bach, M.E., Huang, Y.-Y., Wang, L., Hawkins, R.D., Kandel, E. R. (1996b). Controlling memory formation using regulated expression of a CaMKII transgene. *Science*, in press.
- Morris, R.G.M., Anderson, E., Lynch, A.S., and Baudry, M. (1986). Selective impairment of learning and blockade of long-term potentiation by an N-methyl-D-aspartate receptor antagonist, AP5. *Nature* **319**, 774–776.
- Oberdick, J., Smeyne, R.J., Mann, J.R., Zackson, S., and Morgan, J.I. (1990). A promoter that drives transgene expression in cerebellar Purkinje and retinal bipolar neurons. *Science* **248**, 223–226.
- Pokorny, J., and Yamamoto, T. (1981a). Postnatal ontogenesis of hippocampal CA1 area in rats. I. Development of dendritic arborisation in pyramidal neurons. *Brain Res. Bull.* **7**, 113–120.
- Pokorny, J., and Yamamoto, T. (1981b). Postnatal ontogenesis of hippocampal CA1 area in rats. II. Development of ultrastructure in stratum lacunosum and moleculare. *Brain Res. Bull.* **7**, 121–130.
- Sambrook, J., Fritsch, E.F., and Maniatis, T. (1989). *Molecular cloning: a laboratory manual* (Plainview, New York: Cold Spring Harbor Press).
- Saucier, D., Hargreaves, E., Boon, F., Vanderwolf, C., and Cain, D.P. (1996). Detailed behavioral analysis of water maze acquisition. II. Contribution of sensorimotor disturbances to acquisition deficits caused by the novel competitive NMDA antagonist NPC17742 and scopolamine. *Behav. Neurosci.* **110**, 103–116.
- Sauer, B., and Henderson, N. (1988). Site-specific DNA recombination in mammalian cells by the Cre recombinase of bacteriophage P1. *Proc. Nat. Acad. Sci. USA* **85**, 5166–5170.
- Silva, A.J., Stevens, C.F., Tonegawa, S., and Wang, Y. (1992a). Deficient hippocampal long-term potentiation in  $\alpha$ -calcium-calmodulin kinase II mutant mice. *Science*, **257**, 201–206.
- Silva, A.J., Paylor, R., Wehner, J.M., and Tonegawa, S. (1992b). Impaired spatial learning in  $\alpha$ -calcium-calmodulin kinase II mutant mice. *Science* **257**, 206–211.
- Stanfield, B.B., and Cowan, W. (1979). The development of the hippocampus and dentate gyrus in normal and reeler mice. *J. Comp. Neurol.* **185**, 423–459.
- Tsien, J.Z., Huerta, P.T., and Tonegawa, S. (1996). The essential role of hippocampal CA1 NMDA receptor-dependent synaptic plasticity in spatial memory. *Cell* **87**, this issue.
- Wang, Y., O'Malley, Jr., B.W., Tsai, S.Y., and O'Malley, B.W. (1994). A regulatory system for use in gene transfer. *Proc. Natl. Acad. Sci. USA*, **91**, 8180–8184.
- Wei, J.J., Hofstetter, R.J., and Hodes, M.E. (1991). Screening and isolation of the cerebellar specific expressed mRNA in mouse. *J. Chuan Hsueh Pao* **18**, 320–331.
- Zhang, Y., Riesterer, C., Ayrall, A., Sablitzky, F., Littlewood, T., and Reth, M. (1996). Inducible site-directed recombination in mouse embryonic stem cells. *Nucleic Acid Res.* **24**, 543–548.